









| | |
|--|-------|
| B Certificate of Compliance | p. 5 |
| C Using the manual | p. 5 |
|  D Getting to know the METER | p. 7 |
| D1 Detailed information on the METER | |
| D2 MANUAL and AUTO operation | |
|  E Installing the METER | p. 14 |
| E1 Requirements of the plant | |
| E2 Line pressure relief | |
| E3 Line flushing | |
| E4 Preliminary checks on the METER | |
| E5 Fitting the extension on the METER | |
| E6 Assembling the METER | |
| E7 Air purging from the lines | |
| E8 Flow-rate check | |
|  F Using the METER | p. 19 |
| F1 Dispensing in MANUAL mode | |
| F2 Dispensing in AUTO mode | |
|  G Customizing the METER | p. 24 |
| G1 Customization menu | |
| G2 Frequently used PRESET values | |
| G3 Units of measurement | |
| G4 Decimal digits | |
| G5 Automatic RESET | |
| G6 Stop precision in AUTO mode | |
| G7 Calibration | |
|  H Maintenance of the METER | p. 35 |
| H1 Replacing the batteries | |
| H2 Cleaning the filter | |
|  L Product Identification | p. 37 |
|  M Construction data | p. 38 |
| M1 Technical Data | |
| M2 Dimensions | |
| M3 Exploded Drawing and Spare Parts List | |
|  N Disposal | p. 40 |



To be requested from the supplier



- The following symbols are used to highlight important notes and information:

Warning

This symbol highlights important aspects as to the CORRECT USE of the METER.

**Warning**

This symbol highlights important aspects as to SAFETY.

**Warning**

This symbol highlights important aspects as to avoid POLLUTION HAZARDS.

- The instructions provided by this manual satisfy both the Installer's and the Users' requirements (Manager and Operators) of the METER. In the Table of Contents a symbol alongside each paragraph indicates the person this information is intended for.

**Operator**

All paragraphs marked with this symbol concern the Operator. The operator is the person who uses the METER to carry out dispensing operations. Therefore the Operator is not expected to read paragraphs other than those marked with this symbol.

**Manager**

All paragraphs marked with this symbol concern the Manager. The METER offers several options (selection of the Unit of Measurement, selection of the Number of Decimal Digits, Calibration, etc.). At least one **skilled Operator** (hereinafter referred to as the Manager) must know this data in order to allow the Operators to use the METER correctly. The Manager must read thoroughly all paragraphs concerning the Manager and the Operator.

**Installer**

All paragraphs marked with this symbol concern the Installer only. He is responsible for installing the METER and is required to read the manual thoroughly, no paragraph omitted.

Warning

This manual is an **essential and integral part of the product** and must be handed over to the personnel who carry out the installation, use and maintenance of the METER.

Read the indications given in this manual as they provide important instructions as to safe installation, use and maintenance.

Keep this manual safe for future reference.

Do not remove, tear or modify any parts of the manual.

In case of loss or damage a new copy can be requested from the manufacturer, provided the relevant code is indicated.

**Warning**

The manufacturer is not liable for any damage to persons, things or the unit itself, if the latter is installed or used incorrectly.

D Getting to know the METER

The METER is a dispensing nozzle for oils and other fluids, to be installed as a final shutoff device at the end of pressurized flexible hoses.

Besides guaranteeing an exact measurement and display of the fluid amount dispensed, when used as a normal nozzle, **the METER also allows the user to PRESELECT the amount to be supplied and automatically stops the dispensing when the pre-set amount has been reached.**

The METER integrates:

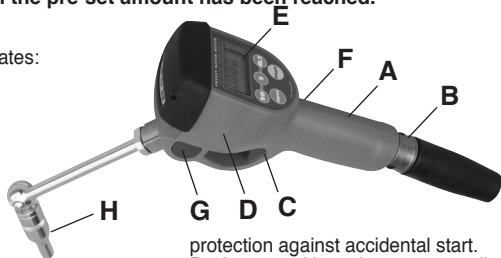

A. An ergonomic handle.

B. A swivel that allows the user to rotate the handle independent of the flexible hose it is connected to, and equipped with a rubber cover.

C. A flow control valve, activated by a trigger, which is equipped with a

protection against accidental start.

D. A meter with oval gears, controlled by an electronic board and equipped with a battery-powered microprocessor.

E. A large liquid-crystal display, integrated in the 5-key keypad, for the communication between the METER and the Operator.

F. A motorized valve shutting system, automatically activated by a microprocessor when dispensing a PRESELECTED amount (AUTO mode).

G. A multi-position extension to adjust the angle of the dripless valve with respect to the handle.

H. A dripless automatic valve.

D1 Detailed information on the METER



Handle

An external shock-resistant plastic cover contains all the components of the METER and provides an ergonomic handle.

The battery pack

The battery pack is placed in the front part of the handle and it is fixed by means of four cross-head screws. The user can easily access this pack to replace the batteries.



Swivel and filter

The METER is equipped with a swivel to be connected to the flexible hose. The swivel is equipped with a 1/2" female thread (BPS or NPT) and houses the filter. The large filtering surface guarantees a reduced pressure loss.

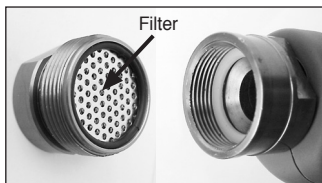

Rubber swivel cover

During installation the swivel may be equipped with a rubber cover to prevent the swivel itself or the metal end of the flexible hose from damaging the vehicle body.

This cover is available in different colours, which can be used as a "colour code" to identify the dispensed product easily.

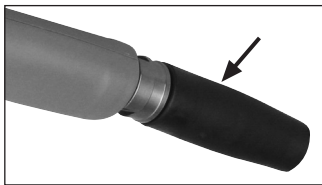

Trigger

The METER is equipped with a balanced valve, controlled by a trigger, which can be activated using just one finger. The trigger, protected against accidental starting, may be:

Released.

The valve is in **closed** position.

**Completely pulled.**

The valve is in **maximum open** position.

**Locked in open position.**

The valve is in **open position for automatic operation.**

**The liquid-crystal display "LCD"**

The METER uses an LCD with the following numeric registers and indications:

- Batch total**
(4 digits, floating point)
- Totals**
(7 digits)
- Indication** of the Total type
(TOTAL / Resettable TOTAL)
- Indication** of the Unit of Measurement
Qts = Quarts
Pts = Pints
Lit = Liters
Gal = Gallons
- Indication** of operation in AUTO mode.

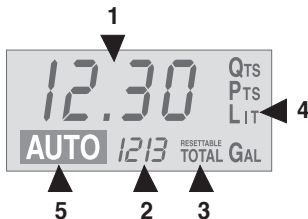
**Warning**

The LCD automatically turns off if the METER is not used for a certain period.

To reactivate the LCD press the **RESET** key.



Keypad

The keypad is of membrane type and is equipped with 5 keys.



Numeric keys:

to be used to set the **PRESET** value (automatic dispense stop value).

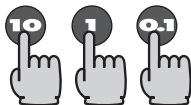

AUTO key:

to be used to select and confirm the **PRESET** value.



RESET key:

to be used to reset the Batch Total and to display the Resettable **TOTAL**.



Warning

During the operations necessary to customize the METER, the keys have extra functions, described in paragraph G.

Meter

To guarantee an accurate measurement of the dispensed amount the METER uses the principle of the oval gears.

Multi-position extension

To guarantee an easy use, the METER is equipped with a multi-position extension. It can be positioned by the operator in **5 different pre-set positions** within a 75° range.

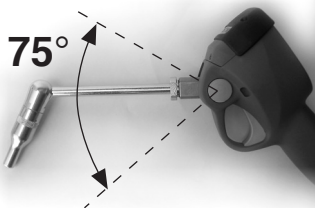

The extension is not free to rotate but it can be, only by activating the **unlocking button**, placed on the side of the nozzle.

Warning

To ensure a correct rotation of the extension it is advisable to:

- Take the extension with your left hand and the METER with your right hand.
- Press the unlocking button with the thumb.
- Hold down the unlocking button, rotate the extension until the desired position is reached.
- Release the unlocking button.
- If necessary, slightly move the extension until you reach an

angular position in which the unlocking button can return to rest position.

leggermente l'estremità sino a raggiungere una delle posizioni angolari in cui il pulsante di sblocco potrà ritornare nella posizione di riposo.

A forced rotation of the extension and an improper use of the unlocking button may damage the METER.

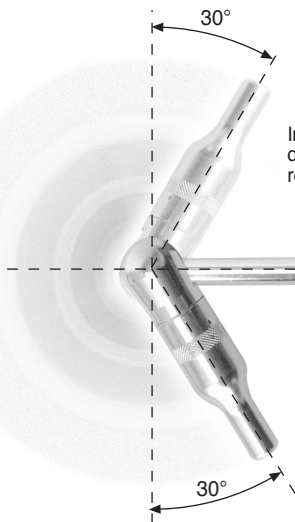

In addition the automatic dripples valve can be rotated of 240°.

D2 MANUAL and AUTO operation



The METER is a PRESETTABLE dispensing nozzle that can be used in two operating modes:

Mode

MANUAL

In MANUAL mode dispensing starts as soon as the Operator operates the trigger.

The only preliminary operation to be carried out by means of the METER keys is the possible resetting (RESET)

of the value previously indicated on the Batch Total.

The operator has to check the dispensing operation personally and to stop it by releasing the trigger when the desired amount is reached.



Warning

The METER has been designed to ensure the maximum safety during use and to avoid oil spillage due to an improper use or the Operator's carelessness.

In particular the METER does not allow **the valve to be locked in open position during MANUAL mode**. This avoids a continuous dispensing should the Operator be absent or has not pre-set an automatic stop value (AUTO mode).

Mode

AUTO

To dispense using the PRESELECTION option, before starting dispensing the Operator must:

- **Select** the desired amount by means of the METER keys as explained in paragraph F2.
- **Confirm** the selected value thus entering the AUTO mode: METER displays the message AUTO and is ready to dispense automatically without requiring the presence of the Operator.

- **Start** dispensing by pulling the trigger and setting it to lock position.

The operator's presence is not necessary: the METER will automatically stop once the selected amount has been dispensed.



Warning

In any case the operator must attend to the METER while dispensing in AUTO mode in order to avoid any oil spillage.



Warning

Read the instructions given in paragraph F2 carefully before dispensing in AUTO mode.

The METER allows the user to lock the trigger in open position only when the display shows the message **AUTO**.

To lock the trigger in open position:

- Pull it completely
- Then release it.

If the message AUTO blinks automatic dispensing cannot be started. If the trigger is completely pulled and afterwards released, it does not remain locked in open position but it closes again thus interrupting the dispensing operation.

The blinking message **AUTO** indicates that **the phase for selecting the desired value is still in progress**, but the AUTO mode has not yet been entered by confirming the displayed value.

The METER automatically unlocks the trigger thus stopping the dispensing when the predetermined value has been reached.

However, during dispensing in **AUTO mode**, it is possible to stop dispensing manually before the desired value is reached by unlocking the trigger.

To unlock the trigger and place it in closed position again:

- Pull it completely
- Then release it.

When the dispensing has been manually stopped, as soon as the AUTO message is displayed, it is still possible to restart the automatic operation as the trigger can still be locked in open position.

The METER automatically exits from AUTO mode after a given period of time (TIME OUT) without dispensing.

E Installing the METER



This paragraph describes the necessary operations to be carried out when the METER is installed for the first time on a new system or to replace an existing nozzle with the METER.

E1 Requirements of the system



The METER has been designed to be used as a component of a **centralized system for the distribution of oils** and other industrial fluids, which must be **manufactured and installed by specialized personnel in compliance with the standards** relevant to such a pressurized system.

To explain the installation and maintenance operations relevant to the METER refer to the following diagram which shows a **typical installation**, as regards the components located right upstream any "dispensing outlet" of the METER.

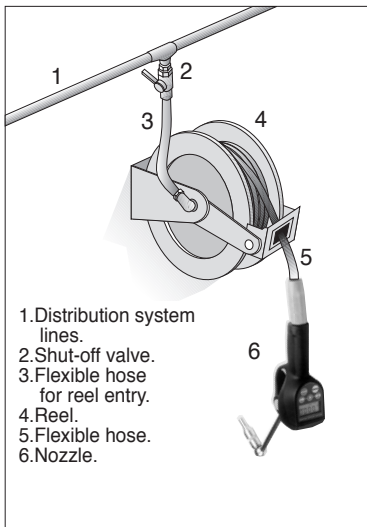

Warning

The **shut-off valve** is necessary to ensure a safe and correct installation and maintenance of the METER without requiring to make the whole system unserviceable.

The structure and complexity of the part of the system before the above mentioned shut-off valve (rigid or flexible power lines, pumps, tanks, valves, etc.) as well as the possible presence of the flexible hose reel can be freely chosen by the Installer as they do not influence the maintenance of the METER.

E2 Line pressure relief



This operation is to be carried out to replace the pre-existing nozzle with the METER nozzle or to dismount the METER for maintenance purposes.



Warning

Failure to carry out this line pressure relief procedure may cause damage to persons or things.

- **Close the shut-off valve.** Otherwise **stop the power supply pump** and make it unserviceable to avoid an accidental re-start during maintenance operations.

- Operate the valve of the nozzle to be replaced (or of the METER to be disassembled for maintenance reasons) dispensing into a suitable container in order to release the line pressure.



Warning

If a **dripless valve** is installed at the end of the nozzle, the pressure inside the line will not decrease to zero, but it may stay at a value of 0.2 - 0.5 bar according to the type of dripless valve used.

- *(For the dismounting of the METER only)* Remove the rubber cover from its coupling on the swivel and move it along the flexible hose in order to have easy access to the swivel.

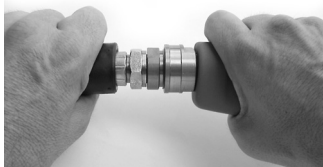

- By means of two wrenches, unscrew the threaded end of the flexible hose from the swivel.



Warning

Be careful to collect any oil leakage into a suitable container.

E3 Flushing the lines



Flushing the lines means to let a given amount of oil flow through them so as to ensure a proper "washing" of the whole system, a correct cleaning and the absence of dirt, contaminated material or processed waste inside the lines before installing the nozzle.

The flushing operation must be carried out on all lines, upstream the nozzle. In case the system is equipped with more than one nozzle, flush the lines which supply the nozzles farthest away from the supply pump first, then proceed with the lines of the nozzles situated nearer the pump.

The flushing procedure depends on the type and features of the system and must be carried out by trained and qualified personnel in compliance with the procedures set down by the installer.

Warning

This operation is absolutely necessary with NEW INSTALLATIONS or if the lines used are contaminated.

You need not carry out this procedure when replacing the nozzle in use.

E4 Preliminary checks of the METER



- Make sure that the threaded end fitted on the flexible hose is suitable for the swivel of the METER provided with:

Female thread 1/2" BSP

or

Female thread 1/2" NPT

- Check that the METER to be installed is **complete** and in **good condition**, making sure that the **filter is clean and correctly installed** (see paragraph "H2").

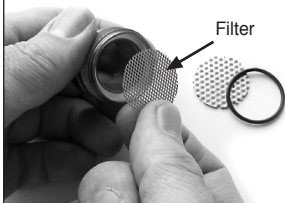

The filter of the METER, characterized by a large filtering surface, has been designed to guarantee a correct filtering and a low pressure loss.

To remove and re-install the filter refer to paragraph "H2".

Warning

The absence of the filter or its improper installation may **cause the meter or the METER valve to block** if dirt is present in the tubes. This situation may occur especially during new installations. To solve these problems **consult a qualified Service Centre.**

E5 Mounting the extension on the METER

Three different types of extensions can be installed on the nozzle METER:

- ADJUSTABLE extension;
- RIGID extension;
- FLEXIBLE extension.

All of them are equipped with an **automatic dripless valve**.

All extensions are equipped with a rigid ending part (external • 12 mm, 3/8" G nut) suitable for being easily connected to the METER without **using any sealant**.

- Remove the plug from outlet A (3/8" G).
 - Make sure that gasket B on the nut is in its seat.
 - Lubricate the gasket and its seat.
 - Tighten end D on METER by means of two wrenches;
- while the first one on outlet A blocks the METER, the second one tightens nut C of end D.
- Before locking nut C orientate valve E.

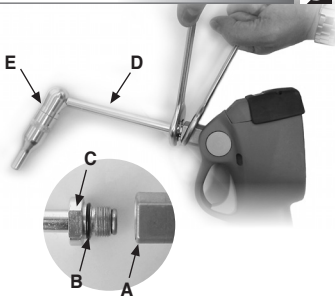

Warning

An improper tightening of the extension may cause it to become loose thus endangering persons or things.

Tighten the ring nut with a torque wrench setting at 3.5 Kg per metre.

E6 Mounting the METER

• Fit the rubber cover of the swivel into the flexible hose, in the direction indicated in the figure, making it slide over the male thread of the hose.

• Apply a thread sealant to the male threads of the flexible hose.

• Tighten the swivel completely by means of two wrenches.

• Make the rubber cover slide towards the valve until it goes into the specially provided seat, located on the swivel.



E7 Air purging from the lines



After the installation of the nozzle a certain quantity of air will be present both inside the flexible hose downstream the nozzle and in the other lines of the system.

To purge the air and to guarantee a **steady flow and a correct calculation of the amount dispensed**, two persons must act as follows:

- With the shut-off valve still closed, insert the extension of the METER into the opening of a container of a suitable capacity, to avoid sprays or spillage which may occur during the initial phase when the flow is irregular.

- While the first person operates the trigger of the METER, the second must partially open the shut-off valve. When the flow begins to steady, the latter will have to set the valve to full open position.

- Go on purging the line keeping the valve of the METER completely open, until a steady flow is reached. At this point release the trigger thus stopping dispensing.

E8 Checking the flow-rate



Once the installation and purging operations have been carried out, it is advisable to check the dispensing flow-rate, which, to ensure a correct operation of the valve, must comply with the range indicated in paragraph M1.

Warning

The METER allows the user to check easily and directly the dispensing flow-rate:

During the operation in **MANUAL** mode, **press and hold down the AUTO key**.

The METER will display the current flow-rate in units per minute.



Batch Total dispensed



Current flow-rate

If the flow rate exceeds the range limits, adjust the components of the system (pumps or balancing valves) to comply with them.



Warning

- The METER has been designed for professional use and must be **used only by adult personnel properly trained for the intended purpose.**
- The METER must not be used outside the operating ranges (see **Technical Data in paragraph M1**) or for fluids other than lubricants and antifreeze mixtures.
- **Do not tamper** with or modify the METER.
- **Regularly check** the good condition of the METER.
- The METER dispenses high-pressure fluids. **Do not point the nozzle to any part of the body.**
- **Use the personal protection equipment recommended** by the national standards relevant to the dispensed products.
- **Do not carry out any maintenance operations on the METER without previously relieving the pressure from the system lines.**
- **The METER is designed for indoor use only.** If used outdoors, it must be sheltered from the rain, snow or direct sunrays.



Warning

In case of manual anti-drip valve, after using, it is important to discharge the overpressure between the chamber (1) and the manual valve (2) of the spout. Carry out this operation while the pump is switched off. Then, unscrew the valve (2). During this discharging operation, do not push the trigger (3).

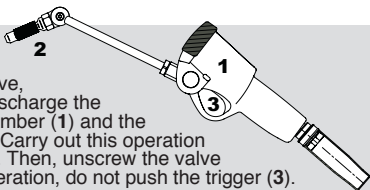

F1 To dispense in MANUAL mode



The METER can be used as a normal nozzle if the Operator does not want to pre-set an automatic stop value.

If the METER is off, type RESET to re-start it.
The METER displays:

Last amount dispensed.



Non-resettable Total.



The METER can be programmed to display the last amount dispensed until the RESET button is pressed or to automatically reset the Batch Total a few minutes after the end of the dispensing operation in MANUAL mode (see "Auto RESET" in paragraph G5).

If the last dispensing has been carried out in AUTO mode, the dispensed amount is never reset, independent of the selection of the Auto RESET button.

Resetting the Batch Total

To reset the batch total press RESET.
The METER will display:

Reset Batch Total.



Resettable Total.

Resetting the Total

To reset the resettable Total, press and hold down the RESET key.
The METER will display:



Resettable Total.

Dispensing

Pull the trigger to dispense

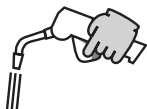

Release the trigger to stop dispensing.



F2 To dispense in AUTO mode



The METER allows the user to select the automatic stop value, "PRESET value", with different procedures:

Direct setting of a new PRESET value.

The METER allows the user to set directly the PRE-SET value by means of the numeric keys.

If the unit is off, type RESET to re-start it.
METER displays:



Not-resettable Total.

To select a new PRESET value (for example 12.3) use the numeric keys.

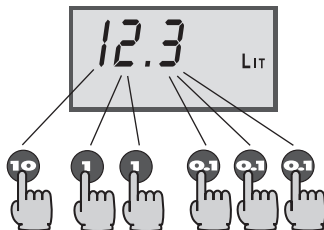

The METER displays:
Selected value.



Blinking message AUTO.

Warning

As long as the message **AUTO** blinks, it is not yet possible to start a new automatic dispensing. If the trigger is completely pulled, when released, it does not remain locked in open position but it closes again thus interrupting the dispensing.

The blinking message **AUTO** indicates that **the phase of the selection of the desired value is still in progress**, but that you have not yet entered the **AUTO** mode by confirming the displayed value.

To confirm the PRESET value, **press and hold down the AUTO key** until the METER displays:



Reset Batch Total.

AUTO message **not** blinking.



Selected value.

Selecting a PRESET value.

The METER allows the operator to use the most frequently used PRESET values without having to set them by means of the numeric keys.

In particular, the METER stores:

- The last PRESET value "**AUTO LAST**".
- Five different PRESET values "**AUTO 1 - AUTO 5**".

The **AUTO LAST** value is automatically updated each time a new PRESET value is set by means of the keypad. The last value used replaces the previous one in the memory.

The **PRESET "AUTO 1... AUTO 5"** values can be freely set and modified according to the procedure indicated in paragraph G2.

If the unit is off, type **RESET** to re-start it. The METER displays:



Last dispensing carried out.



Non-resettable Total.

Press **AUTO**. The METER displays the PRESET value stored in **AUTO LAST**.



PRESET value.



Blinking message AUTO LAST.

Press AUTO again. The METER displays the PRESET value stored in AUTO 1:



PRESET value.



Blinking message AUTO 1.

To display the other stored values, press AUTO as many times as necessary to reach the desired values.



The blinking message will be:

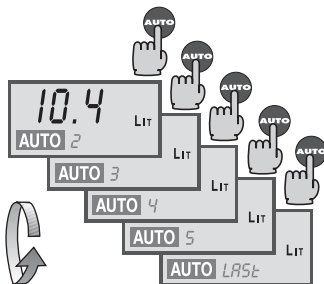

Warning

As long as the AUTO message blinks, it is not yet possible to start an automatic dispensing. If the trigger is completely pulled, when released, it does not remain locked in open position but it re-closes and stops dispensing.

The blinking message **AUTO** indicates that **the phase for the selection of the desired value is still in progress** and that you have not yet entered the AUTO mode by confirming the displayed value.

During this phase it is possible to modify the AUTO value being displayed by means of the numeric keys. The modification of the displayed AUTO value, however, does not change the stored AUTO value. To modify the latter it is necessary to follow the procedure indicated in paragraph G2.

To confirm a PRESET value **press and hold down the AUTO key** until the METER displays:



Reset Batch Total.

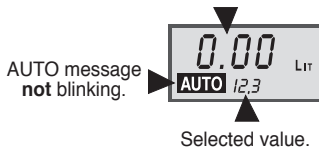

Selected value.

Dispensing in AUTO mode.

• To start dispensing:

Pull the trigger completely and then release it.



The trigger thus remains locked in open position. **Now dispensing can continue even if the Operator is not present.**



• To stop manually dispensing in progress:

Pull again the trigger completely and then release it.



• The dispensing operation can be resumed in AUTO mode within a given time (TIME OUT) from the stop. Within this TIME OUT the METER still allows the locking of the trigger in open position.

• After this TIME OUT the METER still allows the user to continue the dispensing but only in MANUAL mode.

• Automatic stop:

The supply automatically stops when the pre-set value is reached. The AUTO message disappears from the LCD.



• Manual resumption of the dispensing (TOPPING UP):

Once dispensing has been carried out in AUTO mode, the METER allows the user to continue the dispensing operation, if necessary.

Warning

Some time after the automatic stop of dispensing, the METER turns off, but as soon as the RESET key is pressed, the METER turns on again and displays the pre-set value and the value actually supplied (see previous figure).

To carry out the TOPPING UP, **DO NOT type RESET** and pull the trigger.



The dispensed amount is added to the previous one in AUTO mode. The **PRESET value** previously set, displayed in the Total, **starts blinking to indicate that the pre-set value has been exceeded.**



Blinking value.

G Customizing the METER

Customizing the METER means using the options offered by the METER to guarantee an easy, handy and exact use.

The customization of the METER can be carried out by the Manager using the **customization Menu** which permits the following customization **functions**:

Setting the most frequently used **PRESET Values**.

- * Selecting the **Unit of Measurement**.
- * Selecting the **Number of Decimal Digits**.
- * Activating the **Auto RESET** function.
- * Modifying the **Precision Stop factor** (PS factor).
- Modifying the **Calibration factor** (K factor).

* Not available

G1 Customizing menu



Warning

To access the various customizing functions and to select the desired options, **two different actions are indicated on the keys**.

- This symbol indicates that it is necessary **to press the key briefly**, and afterwards release it.



- This symbol indicates that it is necessary **to press and hold down the key** for a few seconds.



To exit from the customization menu, independent of the activity in progress, **press RESET**.

The settings displayed at that moment immediately become operational.

□ To access the customization Menu:

If the unit is off, press RESET to re-start it.



The METER displays:



Warning

RESETTABLE
TOTAL

If the METER displays the **Resettable Total**, wait a few seconds until the METER automatically displays the **Total**.

Only in this condition is it possible to enter the customization Menu.

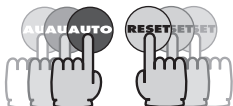

Simultaneously press the AUTO and RESET keys and hold them down until the METER displays:

Blinking



Now you have entered the following activity:

Setting the most frequently used PRESET values:

See paragraph G2 for setting modes.



To go to the next activity.

Press and hold down the AUTO key until the METER displays:

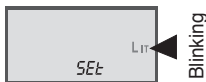

Now you have entered the following activity:

Selecting the Unit of Measurement

See paragraph G3 for the selection modes.



To go to the next activity.

Press and hold down the AUTO key until the METER displays:



Blinking point.



Now you have entered the following activity:

Selecting the Number of Decimal Digits.

See paragraph G4 for selection modes.



To go to the next activity:

Press and hold down the AUTO key until the METER displays:



Blinking



Now you have entered the following activity:

Activating the Auto RESET function

See paragraph G5 for the activation modes.



To go to the next activity:

Press and hold down the AUTO key until the METER displays:



Blinking



Now you have entered the following activity:

Modifying the Precision Stop factor (PS factor).

Vedere il paragrafo G6 per le modalità di modifica.

Warning

To exit from the customization mode, independent of the activity in progress, press RESET.

The settings being displayed become immediately operational.



To go to the next activity:

Press and hold down the AUTO key until the METER displays:



Blinking



See paragraph G7 for modification modes.

Modification of the Calibration factor (K factor)

See paragraph G7 for modification modes.

G2 Frequently used PRESET Values



The METER allows the Operator to store **5 different most frequently used PRESET values** (AUTO 1... AUTO 5), which can be rapidly recalled without having to set them each time by means of the numeric keys.

AUTO 1

AUTO 2

AUTO 3

AUTO 4

AUTO 5

When the METER displays:

Blinking



Index of the PRESET value AUTO 1.

Warning

The first time these activities are accessed, **all the PRESET values stored** (AUTO 1 ... AUTO 5) are set to zero.

Use the numeric keys to set a new PRESET value which will replace the one previously stored in the memory.

If, for example, you want to assign the value 31.2 to **AUTO 1** press:

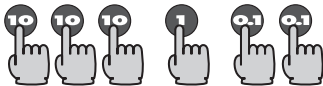

The METER will display:



Warning

By holding down the keys the value continues to vary.

To modify or check the next most frequently used PRESET value, press the AUTO key



The METER will display:

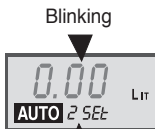

Index of the PRESET value AUTO 2.

and is ready to accept the setting of the PRESET value AUTO 2. Each time the AUTO key is pressed, the next AUTO value is displayed.

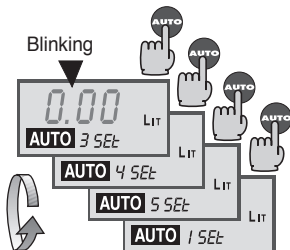

Press and hold down the AUTO key to go to the next activity.



Press RESET to exit from the customization menu.



G3 Units of measurement



The METER allows the user to select one of the following Units of Measurement:

- **QTS** = QUARTS
- **PTS** = PINTS
- **LIT** = LITERS
- **GAL** = GALLONS (U.S. Gallons).

Warning

The above mentioned Units of Measurement refer to the **Batch** total indication.

- If you select the unit LITERS, the **TOTALS will be displayed in LITERS.**
- If you select the unit GALLONS, PINTS or QUARTS, the **TOTALS will be displayed in GALLONS.**

When the METER displays:



Press **AUTO** to go to the next Unit of Measurement.

Go on pressing **AUTO** until the desired Unit of Measurement is displayed.



Press and hold down the **AUTO** key to go to the next activity.



Press **RESET** to **exit** from the customization menu.



Warning

- The modification of the Unit of Measurement does **NOT** require a new Calibration (see paragraph G7).
- If the **TOTAL** indicates a value other than zero, this value is **automatically converted** from LITERS into GALLONS or vice-versa, if necessary, when the Measurement Unit is being modified.

G4 Decimal digits



The METER allows the user to select the number of Decimal Digits by displaying the HUNDREDTH (two decimal digits) or the THOUSANDTH (three decimal digits) of the selected Unit.

The METER displays:



Press **AUTO** to modify the selection. The METER displays:

Blinking point



Press **AUTO** again to go back to the previous selection.

Warning**The METER displays the FLOATING POINT Batch total dispensed.**

Independent of the selection carried out (two or three decimal digits):

- As soon as the amount dispensed exceeds 10 units, the METER displays only **two decimal digits**.
- As soon as the amount dispensed exceeds 99 Units, the METER displays only **one decimal digit**.

Press and hold down the AUTO key to go to the next activity.



Press RESET to exit from the customization menu.

**G5 Auto RESET**

The METER is equipped with an Auto RESET function.

When the function is activated, a few seconds after the end of a dispensing operation, the METER automatically resets the Batch Total.

When the METER displays:

Blinking



Press AUTO to modify the selection.

Blinking



Press AUTO again to go back to the previous selection.

**Warning**

Independent of the selection carried out, **the Batch Total supplied is never reset if the dispensing operation has been carried out in AUTO mode.**

Press and hold down the AUTO key to go to the next activity.



Press RESET to exit from the customization menu.

**G6 Stop precision in AUTO mode****Warning**

The function described in this paragraph concerns **only those who want to obtain the maximum dispensing stop precision in AUTO mode.**

If a slight excess of the pre-set value (a few hundredths of litres) does not cause any problem, **the present paragraph can be ignored.**

The METER in AUTO mode allows the user to obtain a high precision stop, thus dispensing exactly the pre-set

amount without exceeding the PRESET value.

To guarantee this high stop precision, especially when **the unit operates at the maximum allowed flow-rates**, the valve does not close when the PRESET value is reached, **but when the dispensed amount is lower than the PRESET value by a few Unit hundredths.**

To guarantee the stop precision, **this pre-stop value must not be fixed**, but is dependent on the flow-rate used. To allow the Manager to obtain the highest stop precision, the unit has been equipped with a Stop Precision factor, called **PS factor**.

The Manager, during the customization of the METER, **can select a PS factor between ZERO and FIVE.**

By selecting:

PS = 0 a pre-closing equal to **ZERO** is set.

PS = 1

PS = 2

PS = 3

PS = 4

PS = 5 the **MAXIMUM** pre-closing is set.

Warning

The higher the flow rate, the higher the selected PS value. If you select a too high PS value, the dispensed amount may be lower than the pre-set value by some hundredths of a litre.

When the METER displays:

Blinking



Press AUTO to increase the PS factor by one unit.



Blinking



Go on pressing AUTO until the desired PS factor value is reached.

Blinking

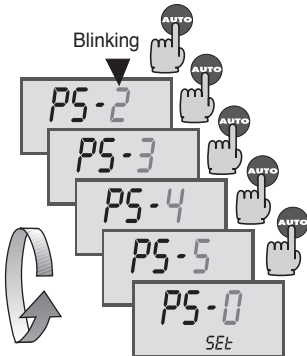

Press and hold down the AUTO key to go to the next activity.



Press RESET to exit from the customization menu.



G7 Calibrating



The METER is equipped with a meter with high-precision oval gears, pre-calibrated in the factory.

Why calibrate?

If the METER is used:

- with fluids having a viscosity close to the limits of the allowed range (such as low viscosity antifreeze fluids or high viscosity oils for gear boxes)
 - in extreme flow-rate conditions (close to the min. and max. values of the allowed range)
- it may be necessary to carry out an on-site calibration.

How to calibrate

The METER allows the user to carry out a rapid electronic calibration by modifying the **Calibration Factor (K Factor)**.

Warning

At delivery all METER are given the same calibration factor:
K Factor = 1,000

This calibration factor guarantees the best accuracy in the following operating conditions:

Fluid: **motor oil type 10W 30.**
Temperature: **20°C**
Flow-rate: **10 liters/min.**

The calibration can be done either as:

- an on-site calibration, by dispensing into a calibrated container, or as
- a direct modification of the calibration factor.

On-site calibration by dispensing into a calibrated container:

When the METER displays:

Blinking



press key "AUTO"; it is possible to start the calibration by dispensing the fluid into a calibrated container.



During dispensing the METER displays:

Batch Total dispensed

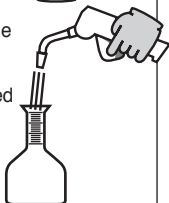

Blinking

The dispensing operation may be freely interrupted and resumed.

The Calibration dispensing is finished, when the level of the fluid reaches the graduated area of the Calibrated Container.



Indicated value



Blinking

Warning

In order to get a good calibration of the METER, use an accurately Calibrated Container of a capacity **not less than 5 liters**.

Purge all air from the unit (see paragraph E7) before carrying out the calibration.

Carry out the calibration dispensing at a steady flow-rate by pulling the trigger completely and keeping it in open position until the container is full.

Do not reduce the flow-rate to reach the graduated area of the calibrated container.

The correct technique to be used at the final stages of the filling operation into the Calibrated Container is "small topping-ups". This is achieved by rapidly pulling the trigger of the METER and then releasing it very quickly.

Press AUTO to confirm the end of the calibration dispensing.

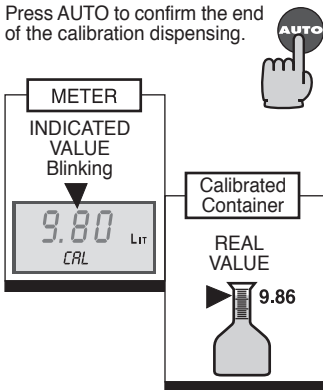

Warning

After dispensing, wait a few minutes to allow the removal of possible air bubbles from the Calibrated Container.

Read the Real value only at the end of this phase as the level in the container may decrease.

Do not wait more than 15 minutes as the METER will exit from the menu and it will no longer be possible to complete the calibration operation.

The METER is ready to accept the modification of the **indicated value** to make it correspond to the **real Value**.

Press the "10" key to increase the indicated value.



Press the "0.1" key to decrease the indicated value.



Warning

Each time a key is pressed, the last digit on the right is modified by one unit.

By holding down the keys, the value changes, slowly at first and then rapidly.

After correction:

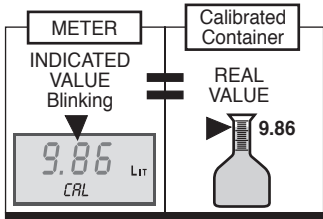

Press **AUTO** again to confirm that the correction of the indicated value has been completed.



The **METER** now calculates the new Calibration Factor (K Factor) and displays:

CAL-End
Blinking alternatively.



New K Factor.

After a few seconds the **METER** automatically **exits from the customization mode** and starts using the new Calibration Factor.

Warning

One dispensing operation is enough to carry out the on-site calibration of the meter.

If you wish to verify the result of this calibration, **carry out a normal dispensing in the same Calibrated Container** without re-entering the Calibration function in the Customization menu.

Direct modification of the calibration factor

The direct calibration of the Calibration Factor is useful when:

- You want to correct the K Factor in use by a known percentage;
- You want to add a K Factor already known.

When the **METER** displays:

Blinking



press key **AUTO**.

Release

Press key **AUTO** again.



The **METER** displays:



Blinking

The **METER** is ready to accept the direct modification of the K Factor.

Press the "10" key to increase the indicated value.

Press the "0.1" key to decrease the indicated value.

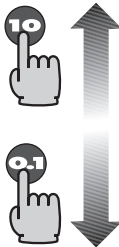

Warning

Each time a key is pressed, the last digit on the right is modified by one unit.

By holding down the keys, the value changes, slowly at first and then rapidly.

Press AUTO to confirm that the correction of the indicated value has been completed.



The METER stores the new Calibration Factor (K Factor) and displays:

CAL-End
Blinking
alternately



New K Factor

After a few seconds the METER automatically **exits from the customization menu** and starts using the new Calibration factor.

H Maintenance of the METER



The only **routine maintenance** operations required for the METER are:

- the replacement of the batteries;
- the cleaning of the filter.

These activities can be easily carried out using standard tools.

Any other **extraordinary maintenance** operation is to be carried out at an authorized Service Centre.

H1 Battery replacement



The METER continuously controls the battery charging state. As soon as the charge decreases below a given level, the METER displays:



Blinking message
"bAtt"

warning the Operator of the need to replace the batteries.

Warning

As soon as the message "bAtt" appears on the display, dispensing in AUTO mode is immediately stopped and it is

no longer possible to lock the trigger in open position.

This prevents the unit from continuing to dispense in AUTO mode even if the PRESET value has been reached, owing to an insufficient battery charge.

Even when the message "bAtt" is displayed, it is still possible to carry out dispensing operations in MANUAL mode.

Although it is possible to carry out tens of dispensing operations in MANUAL mode even when the message "bAtt" is being displayed, **the batteries must be replaced as soon as possible to resume the full functioning capacity of the METER** and to avoid the quality

of the image on the LCD from deteriorating, thus causing metering errors.

When the message "bAtt" blinks, the TOTAL is **constantly updated**, although not displayed.

To replace the batteries:

A. With a small screwdriver (PH cross head, bit No. 1) completely screw off the four screws of the battery pack and remove it.



B. Open the battery pack by removing the cover.

C. Remove the flat batteries.

Warning

The correct polarity is shown in the battery compartment.



D. Install 4 new batteries of type AA 1,5 Volt Alkaline, paying attention to polarity shown on the cover.



E. Place the cover again and fix the battery pack by screwing the four screws.

Warning

METER will start automatically as soon as the battery pack is fixed, carrying out a short SELF-TEST:

- Complete lighting of LCD
- Complete stop of LCD
- Display of serial number of electronic board
- Normal operation mode

The replacement of the batteries does not cause any data loss.

The customization of the METER, previously set, remains operational at the next re-starting.

H2 Cleaning the filter.



The METER is equipped with a removable filter for inspection and cleaning, which is installed inside the swivel.

Warning

Clogging of the filter can strongly reduce the maximum flow-rate supplied by the METER.
Regularly clean the filter, and

check it each time a flow-rate reduction is detected.

To reduce the frequency of cleaning operations, the dispensing system of the METER should be equipped with suitable line filters.

To clean or replace the filter:

- A. Release the line pressure and dismount the METER in compliance with the instructions given in paragraph E2.
- B. Unscrew the 1/2" nut and remove the filtering disk.
- C. Properly clean the filter or use a new filter (see Spare parts list in paragraph M3).
- D. Place the filter again, paying attention to components' positioning.

Warning

- Do not use filters which have been damaged during improper dismounting or cleaning operations.
- Always reposition the filter with the utmost care.

If the filter is in good condition and is correctly installed, it guarantees the good operation of the METER, thus avoiding any dust or foreign bodies, which may lock or damage the METER valve.

- E. Reassemble the METER according to the instructions given in paragraph E6.
- F. Fix the connection again and tighten it at 20 Nm.

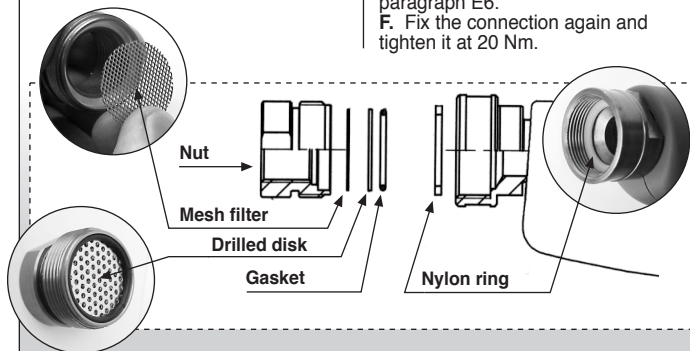

L Product identification



Some technical data of the METER, which is essential for its safe use, is indicated on the CE plate located on the right side of the handle.

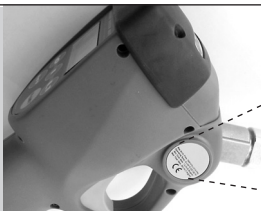

MODEL METER

Max Work. Pres. 7000 KPa (1015 PSI)
Operating Temp. -5/+50°C (+23/+122°F)
Min Flow Rate 1 L/m (0.26 gpm)
Max Flow Rate 30 L/m (7.9 gpm)

CE



M1 Technical data



Measuring principle:

Oval gears

Flow range:

1 to 30* liter/min
0.26 to 7.9 gpm

Pressure range:

50* to 7000 KPa
7 to 1015 psi

Temperature range:

operating: -5 to +50 °C
+23 to +122 °F
storage: -35 to +60 °C
-31 to +140 °F

Viscosity range:

10 to 5000 mPa s

Accuracy:

+/- 0.5 % of indicated value
after on-site calibration.

Repeatability:

+/- 0.2 % of indicated value.

Resolution:

0.005 liter
0.0013 gallon

Pressure loss:

at 10 liter/min 80W oil at 21°C
2.6 gpm 80W oil at 70 °F

with HIGH FLOW spout: 150 KPa
22 psi

with DRIPLESS VALVE: 450 KPa
65 psi

Units of measurement:

Liter / Gallon / Pint / Quart
selectable by the operator.

Indications:

Batch Total:

floating point: 0.000 to 999.9 units

Total/Resettable Total: 999 999 units

Presettable amount:

0.1 to 99.9 units

Batteries:

4 x AA size 1.5 Volt

Expected life: 1 year

up to 10 000 AUTO operation
per year.

AUTO mode automatic inhibition
when "low battery" indication
is shown.

Inlet connection:

1/2" BSP female
1/2" NPT option

Weight:

batteries included
1,50 Kg
0,40 lb

Fluid compatibility:

- lubricating oils (mineral, synthetic)
- antifreeze mixtures

Wetted parts:

- Steel / stainless steel
- Aluminium
- Brass
- Polyurethane
- Acetalic resin
- Nitrile rubber

* with HIGH FLOW spout

M2 Dimensions

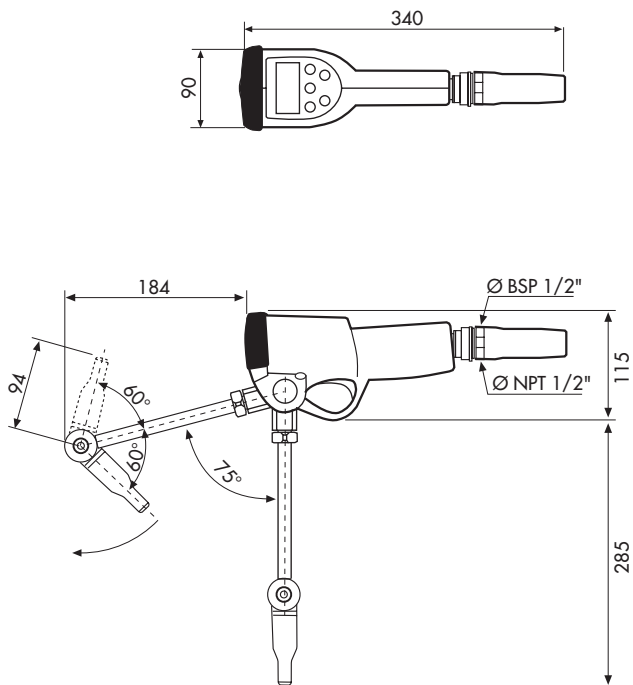

M3 M3 Exploded drawing and Spare Parts List



| Position No. | Part description | Q.ty |
|--------------|-------------------------|------|
| 1 | Rubber protection | 1 |
| 2 | Filter unit | 1 |
| 3 | Locking ring | 1 |
| 4 | Battery pack | 1 |
| 5 | Batteries 1,5 V size AA | 4 |
| 6 | Articulated end | 1 |

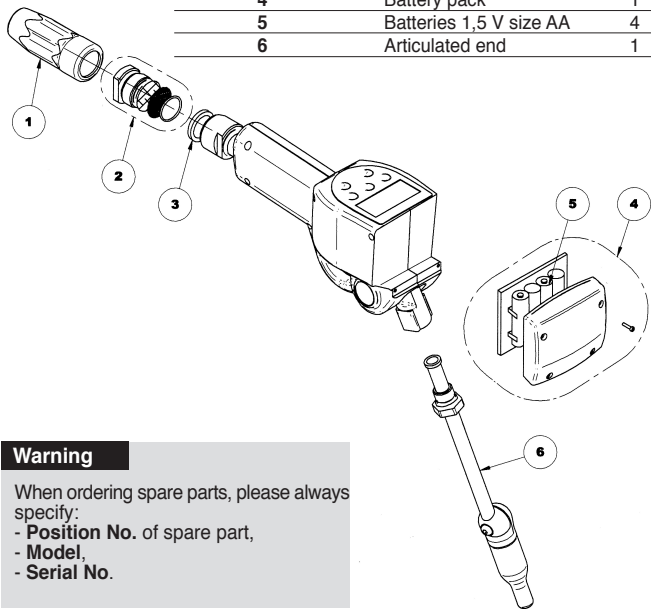

Warning

When ordering spare parts, please always specify:

- **Position No.** of spare part,
- **Model,**
- **Serial No.**

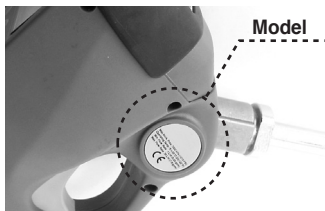

Model

Serial number

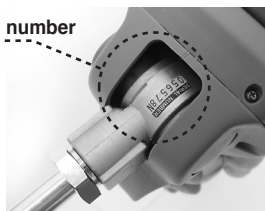



The components must be given to companies that specialise in the disposal and recycling of industrial waste and, in particular, the DISPOSAL OF PACKAGING.

The packaging consists of biodegradable cardboard which can be delivered to companies for normal recycling of cellulose.

DISPOSAL OF METAL COMPONENTS

The metal components, both painted and stainless steel, are usually recycled by companies that are specialised in the metal-scraping industry.

DISPOSAL OF ELECTRIC AND ELECTRONIC COMPONENTS:

these have to be disposed by companies that are specialised in the disposal of electronic components, in accordance with the instructions of 2002/96/EC (see text of Directive below).



ENVIRONMENTAL INFORMATION FOR CUSTOMERS IN THE EUROPEAN UNION

European Directive 2002/96/EC requires that the equipment bearing this symbol on the product and/or its packaging must not be disposed of with unsorted municipal waste. The symbol indicates that this product should be disposed of separately from regular household waste streams. It is your responsibility to dispose of this and other electric and electronic equipment via designated collection facilities appointed by the government or local authorities.

DISPOSAL OF OTHER PARTS:

The disposal of other parts such as pipes, rubber seals, plastic components and cables should be entrusted to companies that special in the disposal of industrial waste.