



Operating manual

HDA eco **Fluid Inventory Control System**

Item No.: 816700001, 816700003, 816700004

Translation of the
original operating manual

Important!

The operating manual is always to be read before commissioning the equipment. No warranty claim will be granted for faults and damage to the equipment arising from insufficient knowledge of the operating manual.

Copyright

© HORN GmbH & Co. KG. All rights reserved.

Text, graphics and layout copyright protected. Reproduction and copying, including in part, only permitted with written permission. Technical changes reserved.

Service Hotline +49 1805 900 301

(0,14 €/Min: on the German landline network, Mobile telephone max. 0,42 €/Min.)

service@tecalem.it

Document No.: 44 1670 001-GB-A
Translation of document-no.: 44 1670 001-DE-A
As of: 11.04.2014

1	Safety instructions	6
2	Technical description	8
2.1	Intended use	8
2.2	Description	8
2.3	Versions	8
2.4	Technical Data	9
2.5	Interfaces of the HDA eco	9
2.5.1	Interface flow meter	9
2.5.2	Interface level control	11
2.5.3	Interface nozzle switch	12
2.6	Accessories	13
3	Assembly Instructions	14
3.1	Electric connection	14
3.1.1	Notes concerning electrical connection	16
3.1.2	Installation of the float switch	17
3.1.3	Installation of the level probe (Optional)	18
3.1.4	Retrofitting the level probe interface	19
3.1.5	Connection of the RS232 / RS422 interface	19
3.1.5.1	RS232-connection	19
3.1.5.2	Printer connection	20
3.1.5.3	RS422-Connection	20
3.1.5.4	LAN Connection	21
3.1.5.5	WLAN connection	21
3.1.5.6	Retrofitting the Data Interface	21
3.2	Calibration of the measuring system	21
4	First steps – HDA eco	23
5	Operating of the Fluid Inventory Control System HDA eco	23
5.1	Switching on	23
5.1.1	Entry of values	23
5.2	Refuelling mode	24
5.2.1	Driver identification (optional)	24
5.2.1.1	Vehicle identification (optional)	25
5.2.1.2	Tank content display (optional)	25
5.2.1.3	Software version display	25
5.2.2	Dispensing without entering a code (optional)	25
5.2.3	Entering the mileage (optional)	26
5.2.4	Entering the order number (optional)	26
5.2.5	Refuelling	26
5.2.5.1	Entry of a preselected quantity	26
5.2.6	Refuelling procedure	26
5.2.7	Data retrieval	27
5.2.7.1	Data retrieval via USB flash drive	27
5.2.7.2	Data retrieval via data cable	28
5.3	Management operating mode / main menu	28
5.3.1	Refuelling data menu	28
5.3.1.1	Show Refuellings	29
5.3.1.2	Print Refuellings (Option ,Printer‘)	29
5.3.1.3	Reset Refuellings	29
5.3.1.4	No. of Refuellings	30
5.3.1.5	USB Report – Refuellings	30
5.3.2	Total Data Menu	30

5.3.2.1	Display Totals	31
5.3.2.2	Reset Totals.....	31
5.3.2.3	USB Report - Totals.....	32
5.3.3	Ident Codes menu	32
5.3.3.1	Code	33
5.3.3.1.1	PIN	33
5.3.3.1.2	Refuelling Limit.....	33
5.3.3.1.3	Maximum Refuelling Time	33
5.3.3.1.4	Mileage or Operating hours Request.....	33
5.3.3.1.5	Mileage or Operating hours Range	34
5.3.3.1.6	Mileage or Operating Hours Status.....	34
5.3.3.1.7	Lock / Release ID.....	34
5.3.3.2	Master ID.....	34
5.3.3.3	USB Report - IDs.....	35
5.3.4	Menu System.....	35
5.3.4.1	Menu Refuelling Options.....	36
5.3.4.1.1	Identification.....	36
5.3.4.1.2	Mileage y/n.....	36
5.3.4.1.3	Previous mileage y/n	36
5.3.4.1.4	Order y/n.....	37
5.3.4.1.5	Nozzle switch y/n.....	37
5.3.4.1.6	Refuelling limit	37
5.3.4.1.7	Max. Refuelling time	37
5.3.4.1.8	Time Out Refuelling.....	37
5.3.4.1.9	Receipt (Option ,Printer').....	37
5.3.4.2	Menu Dispensing Point.....	38
5.3.4.2.1	Pulses / Litres	38
5.3.4.2.2	Post Decimals.....	38
5.3.4.2.3	Automat Lock.....	38
5.3.4.2.4	Device Address.....	38
5.3.4.2.5	Max Zero Refuellings.....	39
5.3.4.3	Menu Extended	39
5.3.4.3.1	Menu Date / Time	39
5.3.4.3.2	Contrast LCD.....	40
5.3.4.3.3	Language.....	40
5.3.4.3.4	Language from USB flash drive	40
5.3.4.3.5	Initialisation / Restoring Factory Settings.....	40
5.3.4.3.6	Info Configuration.....	41
5.3.4.3.7	Activation.....	41
5.3.4.3.8	Communication PIN.....	41
5.3.4.3.9	USB PIN	41
5.3.4.3.10	Menu Interface.....	42
5.3.4.4	Transponder ID.....	45
5.3.5	Menu Fuel Tank	45
5.3.5.1	Stock Control.....	45
5.3.5.2	Tank Parameter Menu (Option Level Probe).....	46
5.3.5.2.1	Form / Tank Shape	46
5.3.5.2.2	Max. Volume / Maximum Tank Volume.....	46
5.3.5.2.3	Height / Maximum Filling Height.....	46
5.3.5.2.4	Density Medium	46
5.3.5.2.5	Sensor Type.....	46
5.3.5.2.6	Offset Sensor	47
5.3.5.2.7	Min. Volume / Cut Off Volume.....	47

5.3.5.2.8	Zero Point Compensation Sensor	47
5.3.5.3	Tank Level (Level Probe Option).....	47
6	Spare parts.....	48
6.1	Exchange of the buffer battery.....	49
6.2	Type Plate and Warning Signs.....	49
7	Trouble shooting What to do, if...?	49
8	Disposal	51
8.1	Return of batteries	51
Annex A.	Menu Structure Management Operation	52
Annex B.	Data export or Import via USB-flash-drive.....	53

1 Safety instructions

The device is a state of the art piece of equipment and has been constructed according to recognized safety specifications. It is nevertheless possible that use of the device will present hazards to the operator or to third parties, or may damage the device or other property. It is therefore essential to act in accordance with these safety instructions, and in particular with those sections identified as warnings.

Warning notices and symbols

In the operating manual, the following signs are used for highlighting important information.



Special information for economical usage of the equipment.



Special information or 'do and do not's for damage prevention.



Information or 'do and do not's for the prevention of damage to persons or equipment.

Intended use



The device shall only be used if it is in specified condition. The device shall only be used for its intended usage, in compliance with all relevant safety regulations, with awareness of the potential risks, and according to the operating manual. Any faults that may impair the safety must be rectified immediately.



The device and its components are only to be used for handling the liquids listed and the purpose described. Using the machine for any other purpose would constitute inappropriate use. The manufacturer is not responsible for any loss arising as a result of this. The risk for this is borne only by the operating company.

Organisational measures



This operating manual should always be available at the site of operation! Each person who is involved with the assembling, commissioning, maintenance and operation of the equipment must have read and understood the entire operating manual. The type plate and the warning notices attached to the device have to be observed and maintained in a fully readable condition.

Qualified personnel



The person operating, maintaining and assembling must be appropriately qualified for their work. The areas of responsibility, competences and supervision of the personnel must be precisely regulated by the operating company. If the operators do not have the required knowledge, they must be trained and instructed. The operating company must also ensure that the contents of the operating manual are properly understood by the operator.

Waters protection



The device is designed to handle water hazardous substances. The relevant local and national regulations to protect the environment have to be fulfilled at the operating place.

Hydraulics



Only persons with special knowledge and experience with hydraulic systems are permitted to work on hydraulic parts and equipment. All lines, hoses and screw joints should regularly be checked for leaks and visible external damage. Any damage must be rectified immediately. Pressurized fluid can cause injuries and fire.

During handling oils, greases or other chemical substances the relevant local and national safety regulations for the product must be observed!

Maintenance and Service



For maintenance works at devices for flammable and/or water endangering substances consider the regulations of the water resources law. Use only authorized service companies.

Before starting any kind of maintenance ensure that all fuel lines are pressureless, completely empty and aerated.

Any changes, modifications or additions to the device are prohibited without consent of the manufacturer. Spare parts have to fulfil the specifications of the manufacturer. This is only guaranteed by original spare parts from the manufacturer.

Electric power



Only qualified electrician or trained persons under the guidance and supervision of a qualified electrician according to electro-technical guidelines are permitted to work on the electrical equipment. Before starting any kind of maintenance or repair work ensure that the device is de-energised.

2 Technical description

2.1 Intended use

The HDA eco is designed as a Fluid Inventory Control System for use in industry, workshops, filling stations and similar facilities. It is intended for the control of dispensing during the refuelling of vehicles with liquid and pumpable operating media.

! The installation and operation of the Wonder Box in explosion hazardous areas is not permitted. This would constitute a risk of explosion!

2.2 Description

The HDA eco fluid inventory control system is designed for controlling and recording the filling of small and medium sized fleets of vehicles at petrol stations or in the yards of vehicle pools. It is however also used in connection with other meters in the field of workshops and industrial enterprises. Up to 2,000 drivers and up to 2,000 vehicles can be administered.

A delivery transaction is initiated once the operator's authorization to fill has been checked. The identification of the operator can take place by entering a code or via a transponder. In addition, other optional requests can be set up: Driver, vehicle, mileage, order number and pre-selection quantity.

The HDA eco receives pulses from a sensor which are proportion to the volume, calculates the dispensed volume via the stored pulse value and displays these two measurements on a two line text display. The measured data are stored in a non-volatile data storage unit with the time stamp of the battery-buffered real time clock. Via various interfaces (e.g. RS232, RS422, USB, LAN, WLAN), it is possible to transfer the measured data for further processing on a PC.

With the help of a fill level switch or a fill level probe, the HDA eco can monitor a tank in such a way so that if a specified fill level is not reached, the extraction point is blocked (protection against idle running). When using a fill level probe, the current fill level can be displayed.

2.3 Versions

Item No.: 81670001	HDA eco
Item No.: 81670003	HDA eco / Version USA
Item No.: 81670004	HDA eco / Cyrillic Display

2.4 Technical Data

Dimensions (WxHxD)	Ca. 190 x 230 x 85 mm
Voltage	100 – 240 V / 50/60 Hz
Ambient temperature	-20°C bis +55°C
Protection class	IP54
Maximum switching current	6,2 A
Weight	Ca. 1 kg
No. of dispensing points	1
Maximum pulse frequency flow meter	240 Hz
Maximum failure elevation of the used measuring equipment	
Flow meter	Ca. 0,1%
Level sensor	Ca. 1%

2.5 Interfaces of the HDA eco

2.5.1 Interface flow meter

Take care that the used combination of flow meter and pump fits to the HDA eco.

The HDA eco can only work with a maximum pulse frequency of 240 Hz.

To find out that the used equipment fits to the HDA eco please recheck the equipment with the following formulas:

Calculation of the pump for a given flow meter:

$$\text{Maximum flow rate of the pump} = \frac{14400}{\text{Pulse value of the flow meter}} \left[\frac{l}{min} \right]$$

The used value for the pulse rate needs the unit [pulse/l] for the calculation.

Calculation of the flow meter for a given pump:

$$\text{Maximum pulse value of the flow meter} = \frac{14400}{\text{Maximum flow rate of the pump}} \left[\frac{\text{pulse}}{l} \right]$$

The value for the flow rate needs the unit [pulse/l] for the calculation.

Calculation example to check the pump for a given flow meter:

Pulse rate of the flow meter: 53,95 pulse/l (FMOG100)

$$\text{Maximum flow rate} = \frac{14400}{\text{Pulse rate}} = \frac{14400}{53.95} = 266.9 \left[\frac{l}{min} \right]$$

Calculation example to check the flow meter for a given pump:

Maximum flow rate of the pump: 64 l/min

$$\text{Maximum pulse value} = \frac{14400}{\text{Flow rate}} = \frac{14400}{64} = 225 \left[\frac{\text{pulse}}{1} \right]$$

Connection of a flow meter (Typical application):

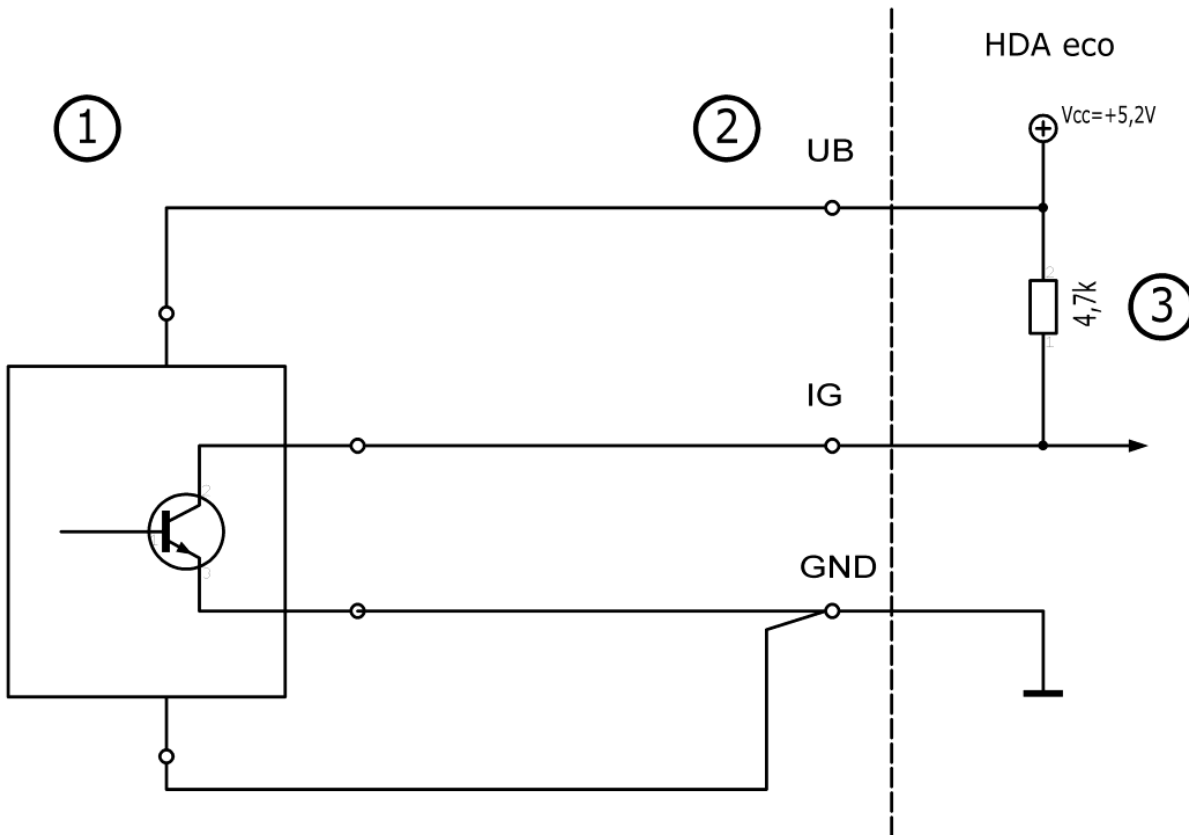

Explanation	
No.	Description
1	External flow meter
2	Connection clamp inside HDA eco
3	HDA eco internal

Specification		
Parameter	min.	max.
Operating voltage	4,9V	5,5V
Supply output current		50mA
Input voltage	-0,20V	5,5V
Pulse duration, "high" or "low"	1,5 ms	
Input pulse frequency		120Hz

! If an external power supply is used for the flow meter, the input voltage of the HDA eco must not exceed the values shown above. Otherwise, the device will permanently be damaged.

2.5.2 Interface level control

Connection of a level control:

Use either a level switch (1) or a level gauge (2). Never use both parallel.

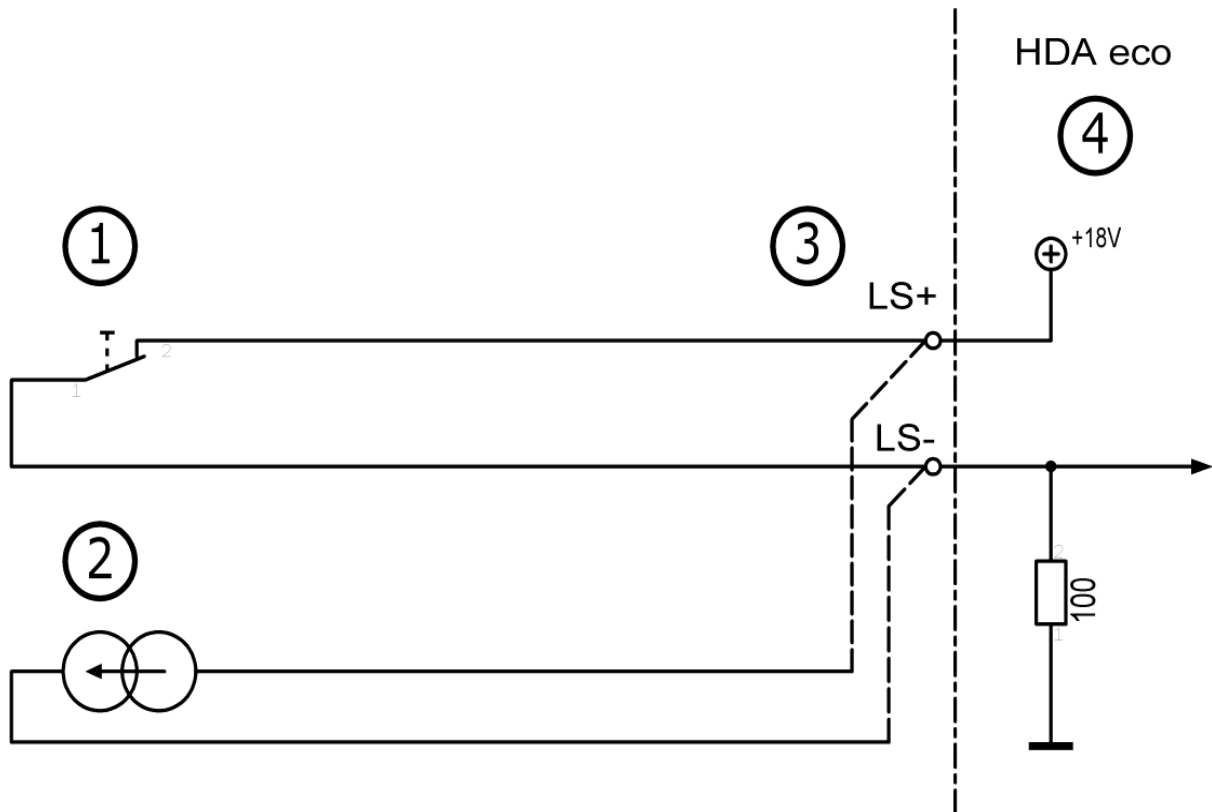

Explanation	
No.	Description
1	Level switch (nc)
2	Level gauge 4-20mA
3	Connection clamp inside HDA eco
4	HDA eco internal

Input configured for level gauge		
Parameter	min.	max.
Supply voltage	16V	22 V
Input current range	3mA	24mA

Input configured for level switch		
Parameter	min.	max.
Switching voltage		22V
Switching current	4.5mA	5.5mA

! The input configuration for connection of a level gauge 4 - 20 mA is an option and must be ordered separately!

2.5.3 Interface nozzle switch

Typical connection of a nozzle switch:

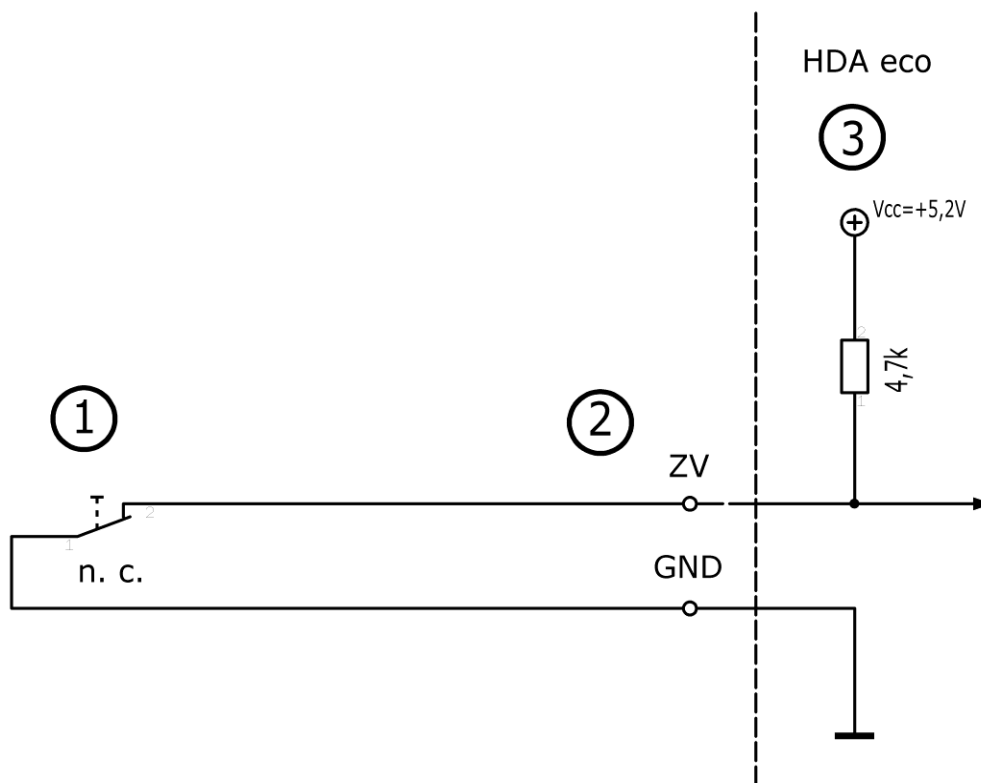

Explanation	
No.	Description
1	Nozzle switch
2	Connection clamp inside HDA eco
3	HDA eco internal

Input Nozzle switch		
Parameter	min.	max.
Switching voltage	5,5V	
Switching current		1.3 mA



A nozzle switch that is qualified for the low current has to be used, e.g. a reed switch..

2.6 Accessories

The following accessories are available for the Wonder Box:

Description		Article-No.
RS422 interface	(Plug-in PCB; please indicate the serial number & year of manufacture of the dispenser when ordering for retrofitting)	233400170
RS232 interface		233400190
LAN Interface		233400032/ -33
WLAN Interface		233400035/ -36
TAG	(Key for driver/vehicle identification)	233400200
USB TAG reader		233400081
USB stick with HD Manager eco (US Version)		616700001
HD Manager - basic version		233500351
HD Manager - full version		233500402
Float switch		233400165
Level probe interface	(Please indicate the serial number & year of manufacture of the dispenser when ordering for retrofitting)	233400160
Activation code fee	(activation by telephone when retrofitting the level probe)	233400470
Level probe 200 mbar	(Tank height max. 6 ½'; cable length 16 ½')	US224010000
Level probe 300 mbar	(Tank height max. 10'; cable length 16 ½')	US224020000
Level probe 500 mbar	(Tank height max. 16 ½'; cable length 23')	US224050000
Terminal box with pressure compensation filter	(for extending the cables of the level probes)	224061000

The right choice of the additional components like pumps or flow meters depends of the medium and the place of usage. For this please contact the HORN TECALEMIT Service.

Service Hotline +49 1805 900 301

or

service@tecalem.it.de

3 Assembly Instructions

The fluid inventory control system is supplied, already installed in the petrol pump and/or in housing.

Before the wiring work always remove the cover of the housing with the keyboard film.

! The flat ribbon cable is very sensitive and should not be pulled or twisted!

Remove the cover as follows:

- Loosen the four lid screws and carefully lift the cover
- Pull out the plug of the ribbon cable attached to the keyboard
- Carefully disconnect the plug of the transponder antenna and pull it out
- Put the cover to the side

3.1 Electric connection

The HDA eco is operated on 100V - 240V / 50/60 Hz. The power consumption is about 5 W. The maximum switching current is approx. 6.3 A.



Work on the electrical equipment of the device may only be carried out by a qualified electrician or by trained persons under the guidance and supervision of a qualified electrician according to electro-technical guidelines.

For trouble-free operation, an electrical connection from the distribution box with residual current circuit breaker must be selected!

Connection plan

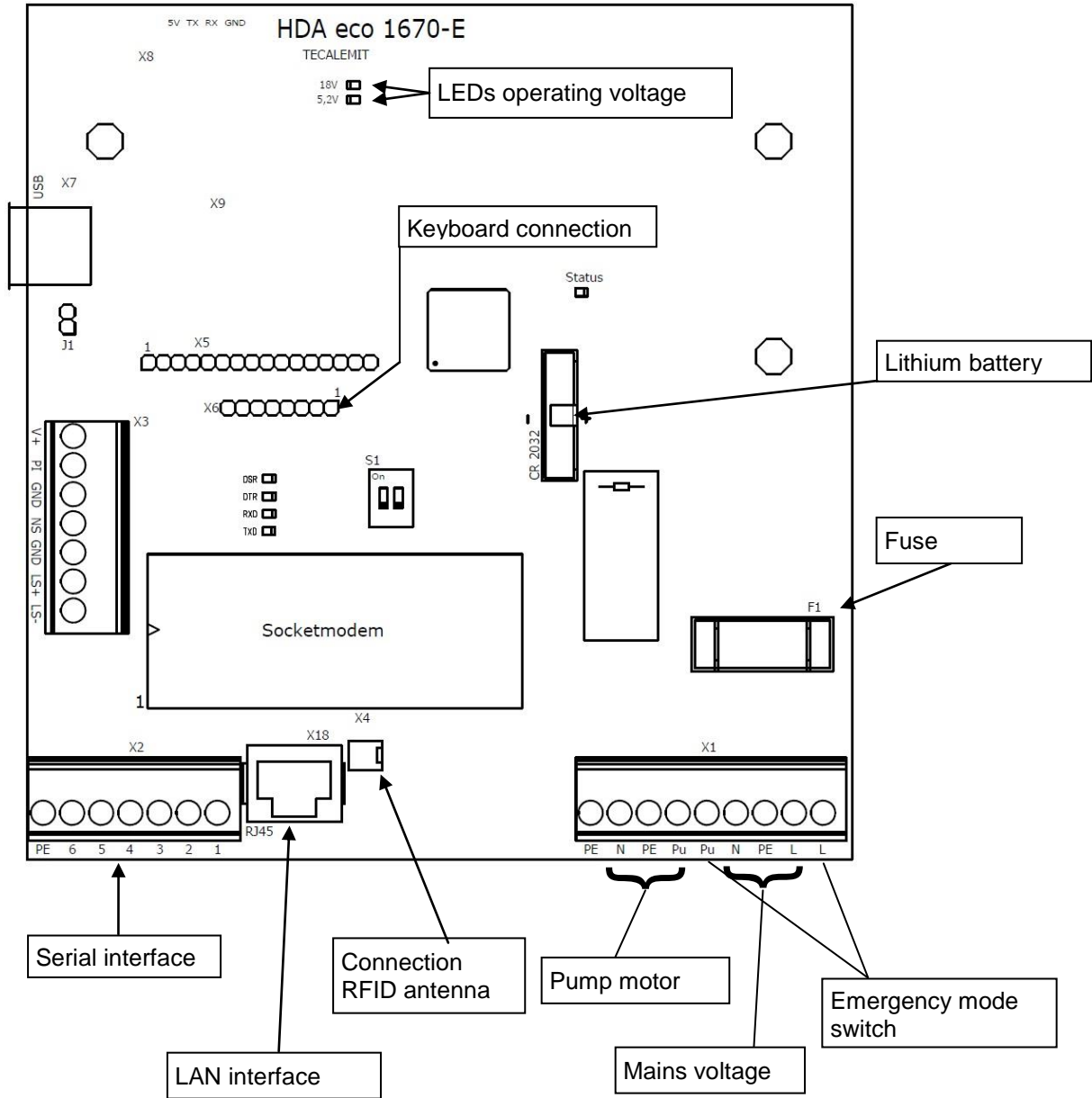

Terminals

Terminal strip	Terminal	Signal	
X1	L	Mains voltage - live	
	PE	Mains voltage - protective earth	
	N	Mains voltage - neutral	
	Pu	Switched phase for motor	
	2. L and Pu	Emergency mode switch	
X2	Socket modem serial		
	1	RS422 GND	RS232 GND
	2	TX-	DSR
	3	TX+	DTR
	4	GND	GND
	5	RX-	RX
	6	RX+	TX
PE	Earth terminal		

X3	V+	Pulse generator operating voltage +5.2V
	PI	Pulse input
	GND	Pulse generator ground
	NS	Enabling contact (potential-free contact)
	GND	
	LS +	Sensor (4-20 mA) operating voltage + or float switch
	LS -	Sensor (4-20 mA) operating voltage - or float switch
X4	RFID antenna connection	
X5	Display connection	
X6	Keyboard connection	
X7	USB port	
X8	Not used	
X9	Not used	
X18	Socket modem LAN	RJ 45 plug LAN

Switch

Switch	No.	Position	Operation
S1 (DIL-Schalter)	1	On	Initialisation
		Off	Normal operation
	2	On	Programming
		Off	Normal operation

LEDs

LED	Function	Comments
18V	18 V operating voltage present	
5,2V	5.2 V operating voltage present	
DSR	Serial interface signal DSR active	Remote station operational
DTR	Serial interface signal DTR active	HDA eco operational
RxD	Serial interface signal RX active	Send data
TxD	Serial interface signal TX active	Receive data

3.1.1 Notes concerning electrical connection

Relay Contact

The relay contact for the pump motor is protected by fuse F1 (6.3 A slow-blow, 5x20).

Emergency mode switch

The emergency mode switch bridges the relay contact for controlling the pump, e.g. in the case of a defective customer activated terminal. In emergency operation mode, no filling is registered!

Battery Exchange

Switch off power supply. Use exclusively type CR2032 (3 V lithium). The used battery has a minimum shelf life of five years.

Socket Modem

- ! Switch off power supply. The data line (X2, X18) is to be disconnected or cut off during installation of the socket modems.
- Observe the polarity. If the direction of installation of the socket modem is incorrect, this can lead to damage affecting the socket modem and the HDA eco! Pin 1 of the socket modem plug slot is located underneath on the left hand side.

Float Switch

The float switch is connected to X3, LS+ and LS-. It must be implemented as a normally closed switch (open = low medium)

Cable Shielding

When using shielded cables take care that they are connected like showed in the picture. Only then the EMR-protection is carried out correct.

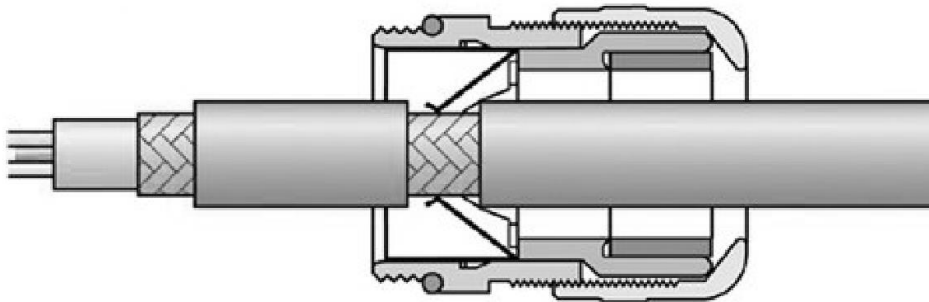

- ! Shielded cables must be used for the control cable of the flow meter and the data cable. Otherwise a negative effect of the function can occur and damages or malfunction can happen.

3.1.2 Installation of the float switch

It is possible to connect a float switch to the HDA eco in order to prevent the tank from being pumped completely empty.

The float switch is not installed on delivery and must be mounted in the tank at the desired fill level by the installation company. The float switch must have normally closed contacts that open when the liquid level drops.

HORN TECALEMIT has a suitable float switch (see section 2.6). Please contact the HORN TECALEMIT SERVICE for the right recommendation.

The 'float switch' function must be activated in the HDA eco automatic dispenser (see section 5.3.5.1 and the float switch must be connected in accordance with the circuit diagram. (see section 3.1).

3.1.3 Installation of the level probe (Optional)

It is possible to connect a level probe (4-20 mA) to the HDA eco. This makes it possible to monitor the level of fuel in the tank on the HDA eco and to switch the pump off when the adjustable minimum level is reached. This protects the pump against damage caused by dry running and prevents any dirt on the floor of the tank from being sucked in.

The 'level probe' function must be activated in the HDA eco automatic dispenser and the probe must be connected in accordance with the circuit diagram (see section 3.1). This function should be activated on ordering the dispenser, but it can also be activated later. Subsequently, the automatic dispenser must be parameterized with the tank values (see section 5.3.5.2).

A suitable level probe must be selected with a measuring range adapted to the tank height (see section 2.6).

The level probe is not installed on delivery and must be mounted on the floor of the tank by the installation company. If the probe cable is extended, a terminal box with a pressure compensation element must be used (see section 2.6).

The sensor should be positioned horizontally at the lowest point of the tank so that the effective installation height (offset) is as close as possible above the bottom of the tank (see sketch). In particular cases it can be necessary to position the sensor suspended above the floor of the tank. Then the offset for this tank must be entered in the corresponding input mask. If there is a difference between the level read off and measured the offset can be corrected accordingly.

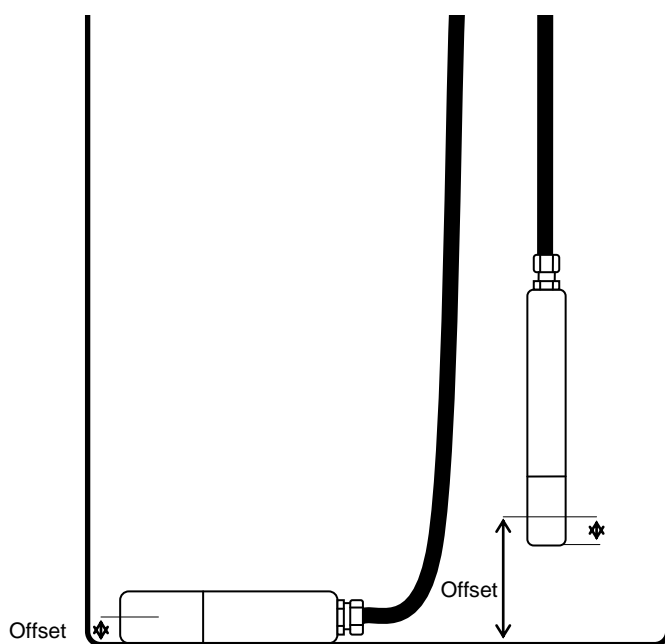

* The offset depends on the type of sensor

Ensure that the sensor is not swinging during and after installation. A protective pipe with bleeding hole on the upper end is to be foreseen in case the sensor is to be installed near a filling or suction line.

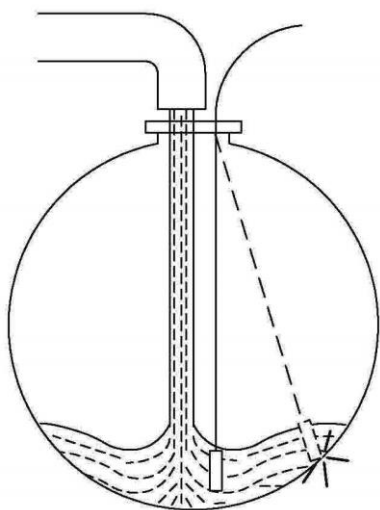

3.1.4 Retrofitting the level probe interface

It is possible to retrofit the optional level probe. Please contact TECALEMIT Customer Service.

3.1.5 Connection of the RS232 / RS422 interface

It is optionally possible to transmit data from the HDM eco to a PC. The HD Manager, HD Manager Basic or HD Manager eco PC software is required for this and the HDA eco must also be fitted with an additional module ('socket modem') for the respective interface.

The PC can be connected via an RS232 or RS422 interface, depending on the local conditions:

3.1.5.1 RS232-connection

In this case interference-free data transmission is possible only up to a cable length of approx. 600" (depending on the type and routing of the cable). A free RS232 interface (COM port) or a USB-to-RS232 adaptor is required on the PC and the RS232 socket modem must be plugged in on the HDM eco.

Connection diagram

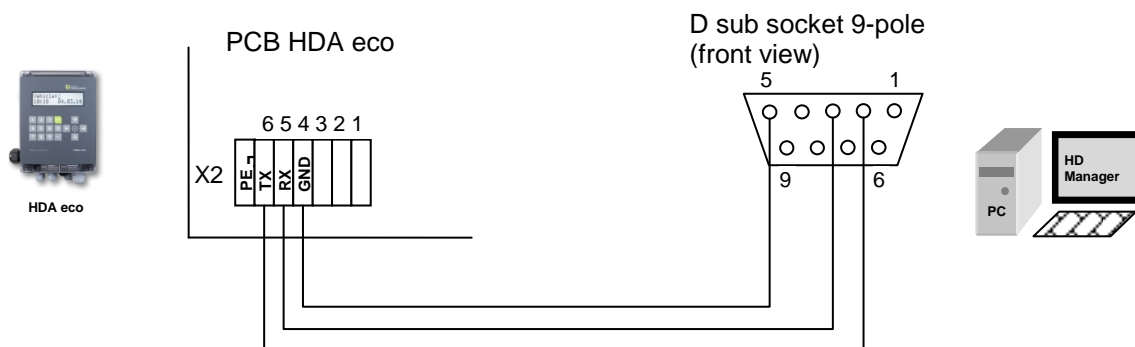

3.1.5.2 Printer connection

Via the serial interface, it is possible to connect an EPSON TM20 RS232 printer. An undisturbed printout is possible with a cable length of approx. 15m (depending on the cable type and how it is laid). The RS232 socket modem must be plugged into the HDA eco.

Connection diagram

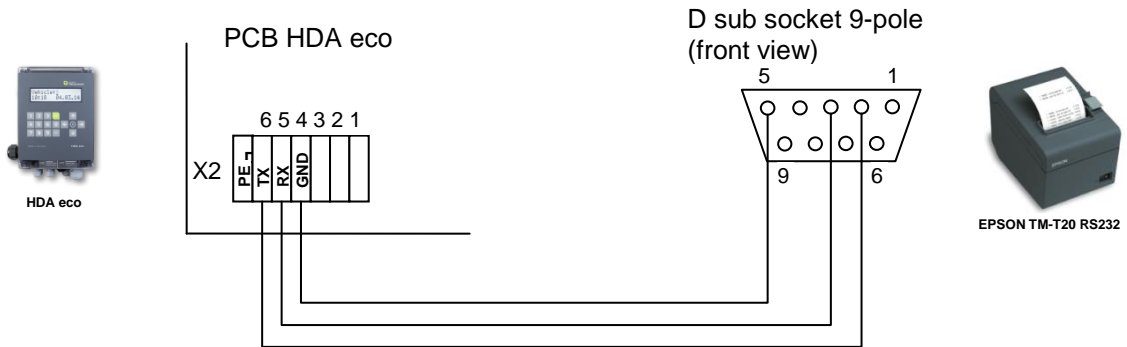

3.1.5.3 RS422-Connection

In this case data transmission is possible up to a cable length of approx. 1300 yards. An RS422-to-RS232 converter is required at the PC end and the 'RS422 socket modem' must be plugged in on the HDM eco. The PC must have a free COM port or a USB-to-RS232 adaptor.

Connection diagram

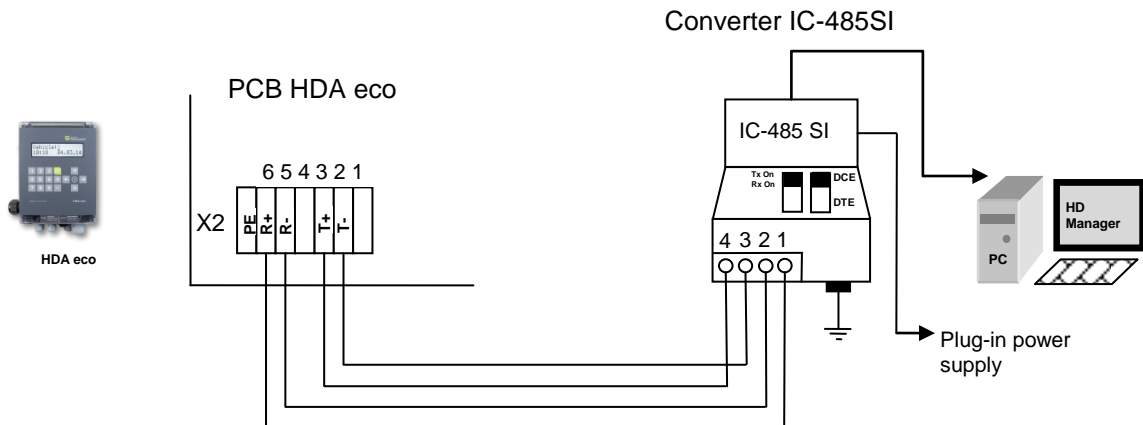

3.1.5.4 LAN Connection

The link via a cable-connected LAN interface to an existing local network enables communication to a PC. The PC must be in the same network. For details concerning the connection and the necessary settings, see chapter 5.3.4.3.10.

Connection diagram

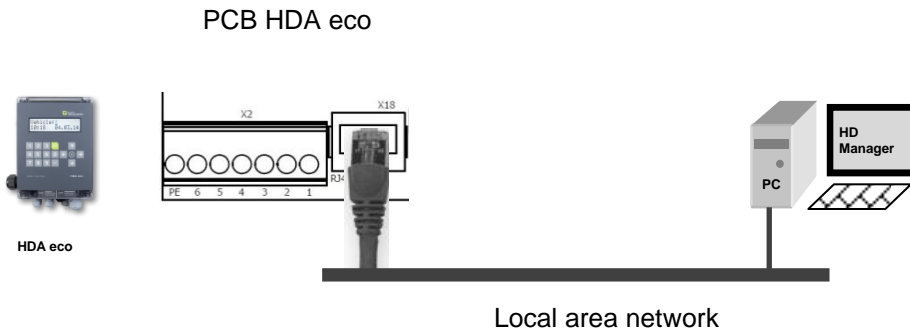

3.1.5.5 WLAN connection

The link via the WLAN interface to an existing WLAN network enables communication to a PC. The PC must be in the same network. For details concerning the connection and the necessary settings, see chapter 5.3.4.3.10.

Connection diagram

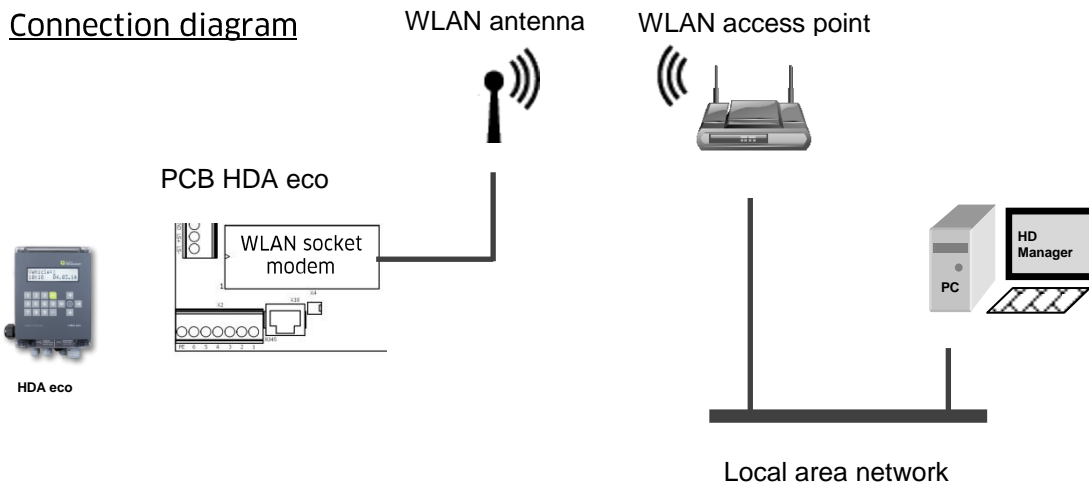

3.1.5.6 Retrofitting the Data Interface

It is possible to retrofit the optional data interfaces.
Please contact TECALEMIT Customer Service.

3.2 Calibration of the measuring system

When the HDA eco works together with a pump system where a flow meter is included, it is necessary to calibrate the system. The HDA eco can only work fail-safe when

the amount of pulses counted by the HDA eco fits to the volume of liquid the system deliver.

The following steps have to succeed for the calibration:

Step 1:

Enter the pulse value of the used flow meter as in sector 5.3.4.2.1 is described. If the exact value is unknown it can be estimated

Step 2:

Make a delivery into a satisfactorily accurate vessel or undertaken by means of a reference meter.

Step 3:

The pulse value is calculated as follows:

$$\text{Pulse value}_{\text{new}} = \frac{\text{Volume}_{\text{displayed}}}{\text{Volume}_{\text{delivered}}} \times \text{Pulse value}_{\text{old}}$$

Example:

A 20 litre measurement vessel is filled; the meter only indicates 19,7 litres. The old pulse value is 53,95. The new pulse value is calculated as follows:

$$\text{Pulse value}_{\text{new}} = \frac{20,0}{19,7} \times 53,95 = 54,77 \text{ (rounded)}$$

Step 4:

As last step enter the pulse value_{new} as in sector 5.3.4.2.1 described. When the last step is succeeded, the measuring system is calibrated.

4 First steps – HDA eco

The HAD eco is equipped with an autonomously working refuelling data acquisition system, which permits the recording and subsequent processing of all refuelling processes.

For this, following entries are possible for every refuelling:

- Driver
- Vehicle
- Mileage
- Order

In the factory setting of the Wonder Box, only the vehicle will be queried. *Vehicle no. 1* was already created with the code “123” so that a trial refuelling is possible.

Display (e.g.):

```
Vehicle:***  
10:29    24.03.12
```

Refuelling can proceed after entering the numbers ‘1’, ‘2’, ‘3’, confirming with ‘ENTER’ and drawing the nozzle.

5 Operating of the Fluid Inventory Control System HDA eco

The user is guided through the operation of the HDA eco by a menu structure (shown in chapter 8). The operating manual is orientated to this menu structure.

5.1 Switching on

After switching on the HDA eco, a function test runs (display test, program version display, memory test, real-time clock test). The automatic dispenser is in the ‘Dispensing’ mode after switching on.

5.1.1 Entry of values

The operation of the automatic dispenser takes place mainly via keyboard. The following basic entries are possible depending on the input fields (Exceptions are treated in the corresponding sections):

- Entry of numerical values (figures)
Entry is made via the number pad. Wrong entries can be deleted character by character with the “◀” key. Press ‘ENTER’ to confirm, ‘EXIT’ to cancel. Where is it meaningful, a minus sign can be entered with the ‘▶’ key.
- Entry of alphanumeric values (letters & numbers)
Entry of numbers is made via the number pad. The entry of letters and special characters is made via the keys ‘▲’ and ‘▼’ confirm the character with the ‘▶’ key. The characters are arranged as follows: ‘a’ - ‘z’, ‘A’ - ‘Z’, ‘0’ - ‘9’, special characters.
Wrong entries can be deleted character by character with the ‘◀’ key. Press ‘ENTER’ to confirm, ‘EXIT’ to cancel.
- Selection of fixed settings

In many input fields only a selection of few alternatives is possible. These are present and can be selected using the "◀" and "▶" keys and confirmed via 'ENTER'. For cancelling use 'EXIT'.

5.2 Refuelling mode

Refuelling can be carried out. Some of the necessary entries are optional. The querying of the inputs in the appropriate input screens as well as additional dispensing parameters can be specified in the menu item 'Dispensing options' (see section 5.3.4.1). Entering is cancelled when for more than 30 seconds no button is pushed. The following steps are necessary to dispense fuel:

5.2.1 Driver identification (optional)

The driver is identified by the associated ID (code or transponder + optional PIN). The IDs are specified in the menu item 'IDs' (see section 5.3.3)

Display (e.g.):

```
Driver:***  
10:29 24.03.12
```

A code with a maximum of 5 digits must be entered. A "*" character appears on the display for each digit entered. Entering leading zeros is not necessary. A transponder tag can be used as ID instead of the code. Mixed operation (operator code and transponder tag) is possible; each ID may be assigned either a code or a transponder tag. The transponder tag needs to have a distance of 1 - 2" to the reader. Acceptance is indicated by a short beep tone.

It is possible to additionally issue a PIN with a maximum of 5 digits for each ID (code or transponder), (see section 5.3.3.1.1).

If an incorrect code or an incorrect PIN is entered, or if a transponder tag is used that has not been released, input is disabled for a period of time that is extended with each subsequent incorrect entry.

Display (e.g.):

```
Pin:***  
10:29 24.03.12
```

The current time is displayed in the lower line. After dispensing, the dispensed amount from the last fuelling is displayed in the lower line for 15 minutes after dispensing ends.

Entry of the **master code** or the use of the master transponder switches to the **management operating mode**.

Master code factory setting: 99999. It is absolutely essential to change this code (see section 5.3.3.2)

5.2.1.1 Vehicle identification (optional)

The vehicle is identified by the associated ID (code or transponder + optional PIN) in the same way as the identification of the driver.

Display (e.g.):

```
Vehicle:***  
10:29 24.03.12
```

5.2.1.2 Tank content display (optional)

Using a level switch:

It is possible to switch to the tank content display from the input screens for the driver or vehicle identification by pressing the '▼' button. The contents information full / not full are displayed. (Only if the level switch is installed and set up.)

Display (e.g.):

```
Tank full/not full
```

The display only stays as long as the '▼' button is pressed!

Using a level probe:

It is possible to switch to the tank content display from the input screens for the driver or vehicle identification by pressing the '▼' button. The contents in percentage, the measured level and the contents in litres are displayed. (Only if the level probe is installed and set up.)

Display (e.g.):

```
Tank 20%  
510mm 68000L
```

The display only stays as long as the '▼' button is pressed!

5.2.1.3 Software version display

It is possible to switch to the software version display from the input screens for the driver or vehicle identification by pressing the '►' button.

Display (e.g.):

```
Version:4.020
```

The display only stays as long as the "►" button is pressed!

5.2.2 Dispensing without entering a code (optional)

If Code query: 'none' has been selected in the dispensing options in section 5.3.4.1.1 I, dispensing is possible without entering a code by pressing the 'ENTER' key. Nevertheless, if a vehicle code is available it can be entered; the dispensed fuel will then be assigned to it.

Display (e.g.):

```
Code:***  
10:29 24.03.12
```

The code query serves only to switch to the management operating mode with the master code (see section 5.3).

Notice: If “*ID query: none*” has been selected and the *Order* and *Mileage* queries have been deactivated too, dispensing begins as soon as the “ENTER” key is pressed or the nozzle is drawn when a nozzle switch is installed.

5.2.3 Entering the mileage (optional)

A 1 to 8-digit mileage can be entered directly. A mileage check can be carried out if necessary (see dispensing options).

Display (e.g.):



```
Mileage: 12000
10:29 24.03.12
```

For a downstream refuelling data evaluation the mileage must be assigned to a vehicle, i.e. the vehicle must be queried!

5.2.4 Entering the order number (optional)

An alphanumerical value with a max of 8 digits can be entered.

Display (e.g.):

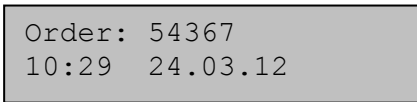

```
Order: 54367
10:29 24.03.12
```

5.2.5 Refuelling

After all queried parameters have been entered, refuelling is requested.

Display (e.g.):

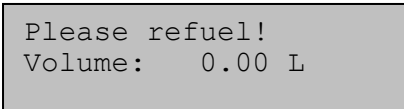

```
Please refuel!
Volume: 0.00 L
```

5.2.5.1 Entry of a preselected quantity

It is possible to enter a preselected quantity before drawing the nozzle. To this end the desired quantity in litres is entered directly using the numeric keys. After having pressed the first numerical key or ‘ENTER’, the display changes and indicates the preselected quantity.

Display (e.g.):

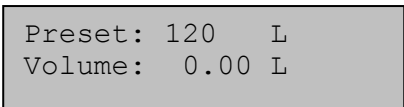

```
Preset: 120 L
Volume: 0.00 L
```

The preselection quantity is confirmed with ‘ENTER’; the entry of the preselection quantity is cancelled with ‘EXIT’. After pressing ‘EXIT’, a normal refuelling procedure is initiated without using the preselected quantity.

5.2.6 Refuelling procedure

After drawing the nozzle, the pump is switched on.

Display (e.g.):



The dispensed quantity is updated continuously during dispensing.

Dispensing can be stopped using the 'EXIT' button, even before the nozzle has been drawn. The time and quantity limits specified in the Menu Refuelling Options (5.3.4.1) apply to the refuelling procedure.

Completion of dispensing by replacing the nozzle, pressing the 'EXIT' button or reaching the preselected quantity / dispensing limit is shown by a corresponding message for approx. 5 seconds.

Display (e.g.):

```
Refuelling done!  
Volume: 789,5 L
```

If dispensing is aborted due to a timeout, the cause of the abortion is shown in plain text on the display.

Display (e.g.):

```
Time Out  
Volume: 789,5 L
```

The dispensed quantity is displayed for 15 minutes or until a new refuelling operation is initiated.

After completion of the refuelling procedure, the dispensing event is saved in the memory of the automatic dispenser with all entered data (driver, vehicle, etc.) plus a time stamp and can be processed running the corresponding management functions (see section 5.3).

5.2.7 Data retrieval

The data is retrieved either via the USB port on the automatic dispenser onto a commercially available USB flash drive or optionally by means of a data connection to a PC (corresponding accessory is required – RS232/RS422 interface). Data retrieval is possible only in the 'Refuelling' mode from the input screens for the identification of the driver or vehicle.

5.2.7.1 Data retrieval via USB flash drive

The dispensing and system data of the HDA eco are written to a USB flash drive. We recommend using the supplied USB flash drive. It is possible to use other USB flash drives but we cannot guarantee for their performance. The data on the USB flash drive can be processed on a PC using the HD Manager refuelling data administration program. To retrieve the data, the USB flash drive is inserted into the opening provided on the left of the automatic dispenser housing. Before doing so, the cover (if any) must be swivelled away after loosening the knurled screw.

Optionally, in order to protect against access by unauthorised persons, an optional preset USB code must be entered after inserting the USB flash drive (see section 5.3.3.2). By default the USB code requisition is not activated.

Display (e.g.):

```
Storing refuelling data
```

To prevent the loss of data, the USB flash drive must not be removed during reading or writing.

After completion of the data retrieval, the retrieved refuelling data are marked as transmitted and are therefore ignored in the case of subsequent data retrievals. See section Annex B for further details, regarding the retrieved data and storage on the USB flash drive.

After completion of the data retrieval, the cover must be replaced and the knurled screw tightened.

5.2.7.2 Data retrieval via data cable

The connection of the appropriate accessory kit to a PC is necessary for data retrieval via a data cable. The data are retrieved and processed via the 'HD Manager refuelling data administration program' – refer also to the separate manual.

5.3 Management operating mode / main menu

The operating mode is switched to management by entering a master *code* or by the use of the master transponder.

Attention:

Master code factory setting: 99999. It is absolutely essential to change this code (see section 5.3.3.2)

In this mode of operation system parameters can be set and various management functions can be performed, such as administration of the dispensing data, totals, IDs etc.

Display (e.g.):

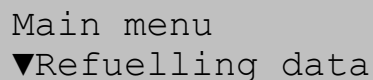

```
Main menu
▼Refuelling data
```

Menu items are selected with the '▲' and '▼' keys and selection is confirmed by pressing the 'ENTER' key.

Sub-menus or menu items can be aborted by pressing the 'EXIT' key.

Pressing the 'EXIT' key in the main menu will return you to the dispensing mode.

5.3.1 Refuelling data menu

The functions for the display and processing of the dispensing data are combined in this menu. The HDA eco automatic dispenser can store approx. 10,000 dispensing data records. The oldest data records are overwritten once the memory is full.

Display (e.g.):

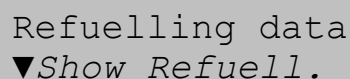

```
Refuelling data
▼Show Refuell.
```

After selecting the appropriate menu item, the respective sub-menus can be used to display or delete the dispensing data, to display the number of stored dispensing events or to create a report on a USB flash drive.

Select with 'ENTER', abort with 'EXIT'.

5.3.1.1 Show Refuellings

Display (e.g.):

```
Refuell.: 53 ♦  
24.03.12 14:44
```

All of the refuellings stored in the memory can be viewed, beginning with the last dispensing event. The refuelling to be displayed can be selected using the '▲' and '▼' buttons. The '◀' and '▶' buttons can be used to select the individual dispensing data (date, quantity, driver, vehicle, mileage, order no). For cancelling use 'EXIT'.

The status of the dispensing event is shown by means of letters / special characters after the time. Meanings:

'T' : Dispensing interrupted due to timeout
'X' : Dispensing data record was transmitted / saved to the USB flash drive

When pressing the 'ENTER' button an input mask appears. There the **displayed dispensing data set and all newer ones** can be marked as not transmitted. So these data can be retrieved from the PC or printed out again following e.g. loss of data or transmission errors.

Display (e.g.):

```
Refuelling data  
recover?
```

Confirm with 'ENTER', abort with 'EXIT'.

5.3.1.2 Print Refuellings (Option ,Printer')

Display (e.g.):

```
Refuell. 53 ♦  
28.10.11 14:44 T
```

All the data stored in the memory can be printed. The delivery (of fuel) to be printed is selected in the same way as described in the menu point, i.e. via buttons,▲' and ,▼'. Using the ◀' and ,▶' buttons it is possible to display details relating to the delivery (data, quantity, driver, vehicle, kilometrage, order number).

The displayed data set is printed by actuating the 'ENTER' button, abort using 'EXIT'.

5.3.1.3 Reset Refuellings

Display (e.g.):

```
Menu Refuellings  
♦ Reset Refuell.
```

Confirm with 'ENTER', abort with 'EXIT'. The data from the stored dispensing events will be marked as already transmitted.

Notice:

The dispensing data are **NOT** physically deleted from the memory, but merely marked as already transmitted. That means that they will be ignored at a new transmission or USB report. It is possible to undo the deletion (see section 5.3.1.1).

5.3.1.4 No. of Refuellings

Display (e.g.):

```
Refuell.: 1532
76.3% engaged
```

The number of refuellings saved and the memory used (in percent) are displayed. The maximum possible number of dispensing data records that can be saved is approx. 10,000.

5.3.1.5 USB Report - Refuellings

A report for the dispensing data not marked as already transmitted is saved as a text file ('DSPDATA.TXT') on a USB flash drive. The file can for example be opened with a text editor on a PC and printed out. The prerequisite for this is that a recordable USB flash drive is inserted in the USB port provided for it on the automatic dispenser.

Display (e.g.):

```
Saving report
1 / 122
```

File (e.g.):

```
HDM eco

USB Report - Refuelling data
.....
....

Date 24.03.12   Time 12:42

Dispensing data: 1
.....
....
Date 04-19-11   Time 09:24
Driver:         12
Vehicle:        15
Order:          17635
Mileage:        115050
Dispensing:     32.49 L

Dispensing data: 2
.....
....
Date 04-20-11   Time 02:38
```

The dispensing data are not marked as transmitted after the creation of the report. They will be saved again with a later report. If necessary, it is advisable to manually 'delete' the dispensing data (see section 5.3.1.2).

5.3.2 Total Data Menu

This menu comprises the functions for the display and processing of the dispensing totals, i.e. the accumulated dispensing quantities. The totals (driver / vehicle) to be processed must be selected beforehand.

Display (e.g.):

```
Main menu
▼Total data
```

Subsequently, the items for the processing of the totals can be selected in the sub-menu.

Display (e.g.):

```
Menu Total data
▼Totals Driver
```

After selecting the appropriate menu item, the respective sub-menus can be used to display or delete the totals data or to create a report on a USB flash drive. Select with 'ENTER', abort with 'EXIT'.

5.3.2.1 Display Totals

Display (e.g.):

```
Driver:    all  ◆
Total1:   110556 L
```

Display (e.g.):

```
Driver:    1  ◆
Total:     190 L
```

The total dispensed quantities 'Total1' (not resettable) and 'Total2' (resettable), the individual totals per vehicle and the total number of dispensing events without code entry can be displayed.

The total to be displayed can be selected using the '▲' and '▼' buttons. For cancelling use 'EXIT'.

5.3.2.2 Reset Totals

Display (e.g.):

```
Menu Total data
◆Reset totals
```

Confirm with 'ENTER', abort with 'EXIT'. The total dispensed quantity 'Total 2', the individual totals vehicle and the total number of dispensing events without code entry are reset. The total dispensed quantity 'Total1' is not reset.

5.3.2.3 USB Report - Totals

A report of the counter readings is saved as text file on a USB flash drive ('DTOTDATA.TXT' for drivers, 'VTOTDATA.TXT' for vehicles). The file can be opened on a PC using a text editor and printed. Therefore a recordable USB flash drive has to be inserted to the USB port of the automatic dispenser.

Display (e.g.):

```
Saving report
100 / 100
```

File (e.g.):

```
HDM eco

USB Report - total data
.....

Date 24.03.12      Time 08:20

Vehicle totals

Total 1:           1430      L
Total 2:           611       L

Vehicle  1:        275       L
Vehicle  2:        569       L
Vehicle 100:        26       L
Vehicle  ---:        5       L
```

5.3.3 Ident Codes menu

In this menu the IDs can be edited and ID reports can be created. The medium for the identification of the driver or vehicle before the start of refueling is called an ID. Various system parameters can be specified for each ID. The master ID is a special ID. It is required in order to access the management mode.

The ID (driver / vehicle / master) to be processed must be selected first.

Display (e.g.):

```
Menu Ident Codes
▼Driver
```

The respective ID can subsequently be accessed via the sub-menu.

Display (e.g.):

```
◆ Driver          3
◆Code: 18734
```

The ID to be edited can be selected using the '▲' and '▼' keys; '-' means that the respective ID has not been set up. In case a transponder has been set as access authorisation for an ID, the entry 'TRANS' appears instead of the code. After selecting an ID switching between its different parameters takes place using the '◀' or '▶' buttons. Press the 'ENTER' button to change the parameter and 'EXIT' to complete the entry.

5.3.3.1 Code

A driver code with one to five digits can be entered. An existing code can be deleted by confirming deletion.

Instead of the five-digit code, a transponder tag can be assigned to an ID. The transponder tag needs to be held at a distance of 2 – 5 cm to the reader. A beep tone indicates that the transponder tag has been read.

5.3.3.1.1 PIN

A 1 to 5-digit PIN can be entered in addition to the code or the transponder tag. In case a PIN was assigned it has to be entered after the code. Only some (or none) of the IDs can be assigned with a PIN.

Display (e.g.):

```
◆ Vehicle      1
◆ Pin:      1234
```

5.3.3.1.2 Refuelling Limit

Here a refuelling limit per refuelling can be entered for the vehicle, maximum 9999 litres.

Display (e.g.):

```
◆ Vehicle      1
◆ Limit:123 L
```

Attention:

If the general dispensing limit for the dispenser is lower, then this applies.

5.3.3.1.3 Maximum Refuelling Time

Here a refuelling time limit per refuelling can be entered for the vehicle, maximum 99 minutes. The default value is 30 minutes.

Display (e.g.):

```
◆ Vehicle      1
◆ Time:      30 min
```

Attention:

If the general dispensing time limit for the dispenser is lower, then this applies.

5.3.3.1.4 Mileage or Operating hours Request

Depending on the vehicle type, prior to refuelling the mileage or operation hours of the vehicle can be entered to calculate the fuel consumption using an optional downstream fuel data processing system. Here it is specified whether the mileage (miles) or operating hours (hrs) are input.

Display (e.g.):

```
◆ Vehicle      1
◆ Request: mileage (km)
```

5.3.3.1.5 Mileage or Operating hours Range

Here a mileage or operation hours range can be input, that defines the maximum allowable difference between two refuellings. This value is checked when either mileage or operating hours are input. Maximum is 9999 miles or hours.

Display (e.g.):

```
◆ Vehicle      1
◆Request: mileage (km)
```

5.3.3.1.6 Mileage or Operating Hours Status

Here the current mileage or operating hours of a vehicle can be viewed. If necessary the status can be edited.

Display (e.g.):

```
◆ Vehicle      1
◆miles: 123456
```

Comment:

It is not necessary to enter the mileage when creating a vehicle. This should be done prior to the first refuelling. A selected mileage window becomes effective only from second refuelling.

5.3.3.1.7 Lock / Release ID

An ID can be blocked or released here. Blocked IDs will not be accepted for refuelling. The Master ID cannot be blocked.

Display (e.g.):

```
◆ Vehicle      1
◆locked:      No
```

5.3.3.2 Master ID

For secure access to the HDA management functions entering a master code with optional master pin is necessary.

The factory presets are: master code '99999'.

Display (e.g.):

```
Master
◆Code: 99999
```

The '◀' and '▶' keys can be used to switch between the code and the PIN entry. Press 'ENTER' to change the respective parameter and 'EXIT' to complete the entry.

Instead of a code, a transponder can be assigned to the master code. After pressing the 'ENTER'-Key, the transponder tag must be held within a distance of 1 - 2" to the reader.

Notice:

In case the master code/PIN was forgotten (or a master transponder was lost) no more management functions are accessible. Please contact Tecalemit service for help.

5.3.3.3 USB Report - IDs

A report for the driver IDs ('DIDDATA.TXT') and a report for the vehicle IDs ('VIDDATA.TXT') are saved as text files on a USB flash drive. The file can be opened on a PC using a text editor and printed. Therefore a recordable USB flash drive has to be inserted to the USB port of the automatic dispenser.

Display (e.g.):

```
Saving report
3 / 100
```

File (e.g.):

```
HDM eco

USB report - IDs
.....
Date: 24.03.12          Time: 14:01
.....

Master
Code:          99999
Pin:           -
.....

Vehicle  1
Code:          123
Pin:          123
.....

Vehicle  2
Code:          234
Pin:           -
.....

Vehicle  3
```



The ID file contains all codes and/or the associated PINs in plain text and should not be made accessible to unauthorised persons.

5.3.4 Menu System

Various system parameters for the operation of the dispenser can be viewed and adjusted in this menu.

Display (e.g.):

```
Menu System
▼Refuell. options
```

Menu items are selected with the '▲' and '▼' keys, confirmed with 'ENTER' and cancelled with 'EXIT'.

5.3.4.1 Menu Refuelling Options

In this menu you can specify the items which are to be queried before a dispensing event. In addition, the inputs of a general dispensing limit, a maximum dispensing time and a timeout are also possible.

Display (e.g.):

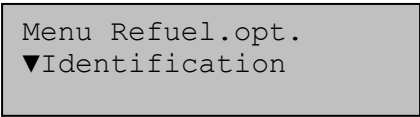

```
Menu Refuel.opt.  
▼Identification
```

Menu items are selected with the '▲' and '▼' keys, confirmed with 'ENTER' and cancelled with 'EXIT'.

5.3.4.1.1 Identification

Display (e.g.):

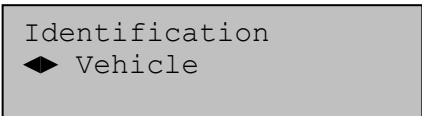

```
Identification  
◆ Vehicle
```

The query of the driver and vehicle ID is optional. You can choose between 'No', 'Driver', 'Vehicle' and 'Both'.

! If Identification: 'no' has been selected and the order and mileage queries have also been deactivated, refuelling will begin as soon as the ENTER button is pressed or the nozzle is drawn when a nozzle switch is installed!

5.3.4.1.2 Mileage y/n

Display (e.g.):

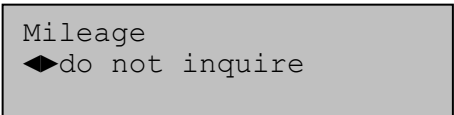

```
Mileage  
◆do not inquire
```

The input of the mileage before each dispensing operation is optional. You can choose between 'do not inquire', 'inquire' and 'always inquire'. If 'always inquire' is selected, the input and checking of the mileage is mandatory. The mileage entered must be as high as or higher than that which was entered last time, the difference between the mileages needs to be smaller than the defined mileage window for the vehicle. In case a consumption calculation according to operating hours takes place for the vehicle in question, the same applies in turn for the entry of the operating hours.

5.3.4.1.3 Previous mileage y/n

Display (e.g.):

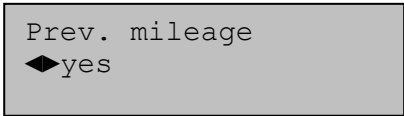

```
Prev. mileage  
◆yes
```

In order to simplify the mileage entry, mileage from the last refuelling event (if available) can be displayed and edited. You can choose between 'yes' and 'no'. In case a consumption calculation according to operating hours takes place for the vehicle in question, the same applies in turn for the display of the operating hours.

5.3.4.1.4 Order y/n

Display (e.g.):

```
OrderNo
◆query
```

The entry of an order no. before each refuelling is optional. You can choose between 'inquire' and 'do not inquire'.

5.3.4.1.5 Nozzle switch y/n

Display (e.g.):

```
Nozzle switch
◆no
```

In order to keep the runtime for the pump working against a closed nozzle as short as possible it is useful to install a nozzle switch. You can choose between 'yes' and 'no'. The default setting is 'no'.

5.3.4.1.6 Refuelling limit

Display (e.g.):

```
Refuell. limit
9999 L
```

The maximum possible dispensing quantity per refuelling operation can be specified here (absolute limit). A quantity between 5 and 9999 litres can be entered. In case the vehicle specific limit is lower than it applies.

5.3.4.1.7 Max. Refuelling time

Display (e.g.):

```
Max. refuel. time:
30 min
```

The maximum possible refuelling time per refuelling operation can be specified here. A value between 1 and 99 minutes can be entered. In case the vehicle specific limit is lower than it applies.

5.3.4.1.8 Time Out Refuelling

Display (e.g.):

```
Time out refuel
2 min
```

The maximum elapsing time during a dispensing event without any medium being dispensed can be specified here. (Example: The nozzle wasn't replaced after refuelling was completed). A time between 1 and 9 minutes can be entered.

5.3.4.1.9 Receipt (Option ,Printer')

Display (e.g.):

```
Receipt
◆yes
```

If this menu point is 'yes', an receipt is printed out on a connected printer. This menu point is only available if the device has the 'printer' option.

5.3.4.2 Menu Dispensing Point

Display (e.g.):



```
Menu Dsp. Point
▼Pulses / litre
```

After selection of the menu items, the corresponding dispensing point parameters can be adjusted in the respective sub-menus.

5.3.4.2.1 Pulses / Litres

The range of the pulse value: 1.00 up to 1000.00

Display (e.g.):

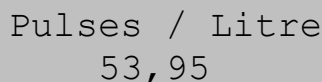

```
Pulses / Litre
53,95
```

The pulse value of the used pulse generator can be set in this menu. The number of volume pulses per litres must be entered. A value between 1.00 and 1000.00 can be entered.

The default pulse value is 53,95, equivalent to the pulse value of the FMOG100 flow meter. (This means 53,95 pulses per litre.)

It can be necessary to change the value after the calibration of the measuring system. How the measuring system can be calibrated see section 3.2.

5.3.4.2.2 Post Decimals

Display (e.g.):



```
Post decimals
◆1
```

The number of decimal points displayed after dispensing can be displayed and changed here.

You can choose between '0' and '1'.

5.3.4.2.3 Automat Lock

Display (e.g.):



```
Automat lock
◆No
```

Here you can set if the automatic dispenser should be blocked for refuelling or enabled again after having been blocked.

You can choose between 'yes' and 'no'.

5.3.4.2.4 Device Address

Display (e.g.):

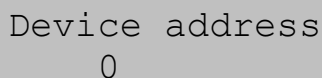

```
Device address
0
```

The device address is necessary for the joint operation of several HDM eco units connected to one serial port (e.g. RS422).

A value between 0 and 9 can be entered.

5.3.4.2.5 Max Zero Refuellings

Several sequential refuelling events that were completed with a dispensing quantity below 500 ml ('zero refuelling') indicate a system error, e.g. lack of fuel, defective pump or meter.

Display (e.g.):

```
Max. Zero dsp.  
5
```

When a value different from 0 has been set for 'max. zero refuellings' the HDA eco blocks automatically after the adjusted number of consecutive zero refuelling occurred. A blocked HDA eco can be enabled again via the corresponding menu in the device once the cause for zero refuellings has been eliminated (see section 5.3.4.2.3). A value of 0 deactivates the blocking function. Values from 0 - 99 can be entered.

5.3.4.3 Menu Extended

Extended system settings or queries can be made here.

Display (e.g.):

```
Menu Extended  
▼Date / Time
```

Menu items are selected with the '▲' and '▼' keys, confirmed with 'ENTER' and cancelled with 'EXIT'.

5.3.4.3.1 Menu Date / Time

Display (e.g.):

```
Menu RTC  
▼Date / Time
```

The settings for the real time clock (RTC) can be made here. Menu items are selected with the '▲' and '▼' keys, confirmed with 'ENTER' and cancelled with 'EXIT'.

5.3.4.3.1.1 Date / Time

Display (e.g.):

```
Date: 24.03.12  
Time: 11:21:04
```

The date (mm-dd-jj) and time (hh:mm:ss) settings of the integrated real-time clock can be inspected and changed if necessary.

You can change the position using the "◀" and "▶" buttons.

5.3.4.3.1.2 Clock Correction

Display (e.g.):

```
Clock correct.  
◆ + 5 sec. / day
```

In order to achieve the greatest possible accuracy of the integrated real-time clock a correction of up to ± 20 seconds per day can be done. The correction is carried out each time at midnight or when the device is switched on. When the device is switched off the clock still runs, but no correction is carried out.

The correction ranges can be set from -20 to + 20 sec. / day using the '◀' and '▶' buttons.

5.3.4.3.1.3 Daylight Saving Time

Display (e.g.):

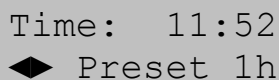

Time: 11:52
◀ Preset 1h

Using the "◀" and "▶" buttons, the system time can be manually set 1 hour forward or backward, depending on the season. The system time is then changed by pressing the 'ENTER' key.

5.3.4.3.2 Contrast LCD

Display (e.g.):

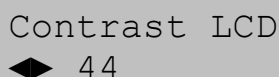

Contrast LCD
◀ 44

The contrast can be decreased or increased using the '◀' and '▶' buttons. The setting range extends from 0 (low contrast) to 63 (high contrast). Changing the default value should only be necessary under extreme operating conditions (very low/very high temperatures).

In case the incorrect contrast has been saved inadvertently (display unreadable): Switch off the device and switch on again keeping the 'EXIT' button pressed (standard contrast will be selected). Subsequently adjust the contrast as described.

5.3.4.3.3 Language

Display (e.g.):

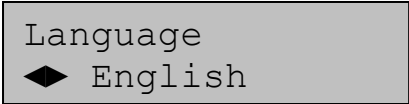

Language
◀ English

Various languages for the driver menus are to be selected using the '◀' and '▶' buttons. One of the languages ('language USB') can be loaded and selected as defined by the driver (see section 5.3.4.3.4).

5.3.4.3.4 Language from USB flash drive

Display (e.g.):

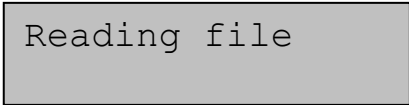

Reading file

It is possible to load an additional language for the user guidance from a USB flash drive. The prerequisite for this is that a USB flash drive containing a suitable language file 'LANGUAGE.CSV' is inserted in the USB port provided for it on the automatic dispenser. For further information see Annex B.

5.3.4.3.5 Initialisation / Restoring Factory Settings

Display (e.g.):

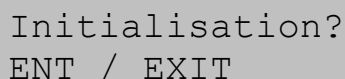

Initialisation?
ENT / EXIT

The device can be initialised here. Some of the factory settings are restored. Dispensing data records and non-resettable totals (Total 1) are not deleted. The following values are manipulated:

The driver and vehicle totals as well as the resettable counter 'Total 2' are cleared
The non-resettable counter Total 1 is not deleted
The dispensing data records are marked as transmitted
All ID codes are deleted and the parameters re-initialised
The 'Master code' is set to "99999" without Master Pin
The 'Dispensing limit' is set to 99999 L
The 'Maximum ref. time' is set to 30 minutes.
The 'Ref. Timeout' is set to 2 minutes
The 'Contrast' of the LCD is set to 44
The 'Communication code' is deleted.
The 'Lock automat' is released

5.3.4.3.6 Info Configuration

This display is intended for service purposes. It provides information about the configuration of the automatic dispenser.

Display (e.g.):

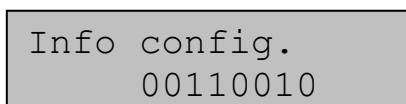

```
Info config.  
00110010
```

5.3.4.3.7 Activation

This display is intended for service purposes. It can be used to change the configuration of the automatic dispenser

Display (e.g.):

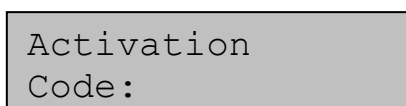

```
Activation  
Code:
```

NOTE! Incorrect entries made by unauthorised persons can result in incorrect functioning of the automatic dispenser!

5.3.4.3.8 Communication PIN

Display (e.g.):

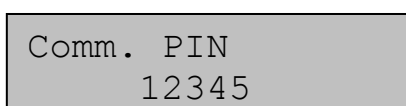

```
Comm. PIN  
12345
```

Here an optional communication PIN for the transmission of data to the HD Manager PC program can be viewed (but not changed). The communication PIN can only be set or deleted using the HD Manager program.

5.3.4.3.9 USB PIN

Display (e.g.):

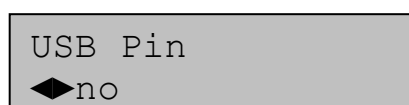

```
USB Pin  
◆no
```

Here it can be specified if the retrieval of the refuelling data via USB flash drive in dispensing mode is to be protected against unauthorised access by the input of master code or by the use of the master transponder.

You can choose between 'yes' and 'no'.

5.3.4.3.10 Menu Interface

Display (e.g.):

```
Menu Interface
▼LAN Ident. No.
```

This menu is only available if a LAN or WLAN socket modem is present (option). This is where it is possible to enter the necessary parameters for operating the respective socket modem. If necessary, a network administrator should be consulted for the correct settings and adjustment to the existing network. Select the menu points using the '▲' and '▼' buttons and confirm with 'ENTER', abort with 'EXIT'.

5.3.4.3.10.1 LAN Ident. No. (LAN + WLAN)

Display (e.g.):

```
LAN Ident. No.:
01823481
```

This is where you can see the LAN identification number for clear identification of the HDA eco in the network (unchangeable). The HD manager computer program can identify the HDA eco via the LAN identification number if several devices are in the network. Leave the menu point with 'EXIT'.

5.3.4.3.10.2 Signal (WLAN)

Display (e.g.):

```
Level      : 67%
Quality    : 59%
```

This is where the signal level and the quality of the connection to the existing WLAN network can be examined. Higher values indicate a better connection.



This menu point is helpful in order to optimize measures for improving reception quality (e.g. external aerials, repeaters etc.).

5.3.4.3.10.3 USB Configuration (LAN + WLAN)

Display (e.g.):

```
USB pen drive
insert
```

Optionally, the LAN or WLAN network configuration of the HDA eco can be entered directly on the device or created conveniently with the aid of the HD Manager 8 computer program and stored on a USB stick (HD Manager 8: Settings → Settings → Miscellaneous → HDA - (W)LAN / GPRS). In this menu, the previously stored configuration is imported from the USB stick into the HDA eco. Following this, you can leave the 'Interface' menu. As a general rule, further settings are not needed.

5.3.4.3.10.4 Restart Time (WLAN)

Display (e.g.):

```
Zeit
◆ 23:00
```

This is the place where a time can be selected, to which the WLAN Socketmodem is restarted once a day and at the WLAN network registers itself again. A periodic restart can create remedy with sporadic connecting difficulties. In stable WLAN networks factory setting „off“ can be used

5.3.4.3.10.5 SSID (WLAN)

Display (e.g.):



SSID:
WLAN-Home

This is the place where the SSID (Service Set Identifier) of the existing WLAN network has to be entered, i.e. the one which the HDA eco should register with. The SSID is normally defined in the WLAN Access Point. Alphanumeric characters can be used (see chapter 5.1.1).

5.3.4.3.10.6 Passphrase (WLAN)

Display (e.g.):

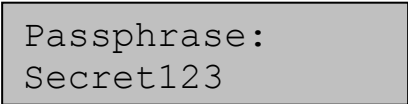

Passphrase:
Secret123

This is the place where the passphrase (also known as the password) of the existing WLAN network has to be entered, i.e. the one which the HDA eco should register with. The passphrase is normally defined in the WLAN Access Point. Alphanumeric characters can be used (see chapter 5.1.1 Fehler! Verweisquelle konnte nicht gefunden werden.).

5.3.4.3.10.7 Encryption (WLAN)

Display (e.g.):

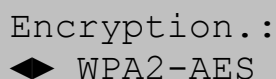

Encryption.:
◆ WPA2-AES

This is where the encryption method used in the existing WLAN network is to be selected. The encryption method is normally defined in the WLAN Access Point.

5.3.4.3.10.8 DHCP (LAN + WLAN)

Display (e.g.):



DHCP:
◆ on

If the existing network which the HDA eco is supposed to be connected to has a DHCP server, this is where the 'on' setting should be selected. The integration of the HDA eco in the network takes place automatically. As the case may be, the setting under the 'Port' menu point (chapter 5.3.4.3.10.12) should be adjusted. Further settings are not necessary.

If no DHCP is supported in the existing network, this is where the 'off' setting should be selected. The following network settings are to be carried out manually

5.3.4.3.10.9 IP Address (LAN + WLAN)

Display (e.g.):

```
IP Address:
192.168.011.025
```

If network settings are set manually (cf. chapter 5.3.4.3.10.4), this is where the IP address of the HDA eco is entered. Care should be taken that a free address is selected. Using the ◀ and ▶ buttons navigation takes place in the entry field. The address is entered using number buttons.

If DHCP has been activated, this is where the IP address given by the DHCP server can be viewed (but not changed) once the first data transfer has taken place.

5.3.4.3.10.10 Subnet Mask (LAN + WLAN)

Display (e.g.):

```
Subnet Mask:
255.255.255.000
```

If network settings are set manually (cf. chapter 5.3.4.3.10.4), this is where the subnet mask is entered for the network. Using the ◀ and ▶ buttons navigation takes place in the entry field. The address is entered using number buttons.



A typical sub net mask for smaller network is 255.255.255.000. If DHCP has been activated, 000.000.000.000 appears here.

5.3.4.3.10.11 IP Gateway (LAN + WLAN)

Display (e.g.):

```
IP Gateway:
192.168.011.002
```

If network settings are set manually (cf. chapter 5.3.4.3.10.4), this is where the IP address of the network gateway is entered. Using the ◀ and ▶ buttons navigation takes place in the entry field. The address is entered using number buttons.



The standard gateway address of the existing network is shown on the start page of the HD Manager 8 computer program. If DHCP has been activated, 000.000.000.000 appears here.

5.3.4.3.10.12 Port (LAN + WLAN)

Display (e.g.):

```
Port
54937
```

This is where the address should be entered of the port where communication with the HD Manager computer program is supposed to take place. It is recommended that the standard port 54937 is used. The setting must be identical with the corresponding setting in the HD manager program. This also applies if several HDA eco communicate with a computer program.



If, for example, two HDA eco have to communicate in an existing network, however each with a different computer, two different ports have to be selected for the respective HDA eco / PC pairs using the HD Manager 8 computer program.

5.3.4.3.10.13 MAC Address (LAN + WLAN)

Display (e.g.):

```
MAC address :
0018FC00019A
```

This is where the MAC address of the socket modem can be viewed.



If network disruption arises, this menu point may be of interest to the network administrator when looking for errors.

5.3.4.4 Transponder ID

Display (e.g.):

```
ID 002
01 04 FA C7 8C
```

Transponder tags and the associated ID, if any exist, can be identified. The transponder tag needs to be held at a distance of 2 - 5 cm to the reader. To cancel use 'EXIT'.

5.3.5 Menu Fuel Tank

The function of the tank monitoring as well as tank parameters (level probe option only) can be set in this menu.

Display (e.g.):

```
Menu Fuel Tank
▼Stock control
```

5.3.5.1 Stock Control

Stock control of the tank contents including blocking of the dispensing point in case of empty tank can be switched on or off. This applies both to control by means of a low medium contact (e.g. float switch) and to the control and display of the tank contents by means of a level probe (optional).

Display (e.g.):

```
Stock control
◆ no
```

You can choose between 'yes' and 'no'. When the setting is 'no', the '▼' key has no function. The tank volume is not displayed.

Note:

In the case of use of the low medium contact, the automatic dispenser is disabled when the contact switches from the closed to the open state. The level at which disablement takes place when a level probe (optional) is used depends on the setting of the disable volume (see section 5.3.5.2.7).

5.3.5.2 Tank Parameter Menu (Option Level Probe)

In the case of use of a level probe, it is necessary to parameterise the probe and the associated tank as accurately as possible in order to obtain exact level values. You can switch between the different tank parameters using the '◀' or '▶' buttons. Press the 'ENTER' button to change the parameter and 'EXIT' to complete the entry.

Instructions for the installation of the level probe in the tank can be found in section 3.1.3

5.3.5.2.1 Form / Tank Shape

The form of the employed tank can be set here. If there is no tank, then accordingly no tank is set (shape '---').

Display (e.g.):

```
Tank parameters
◆Form Cyl V
```

Change the tank form using the buttons '◀' and '▶▶'. There is a choice of the tank forms Cube, Cylinder vertical ('Cyl V'), Cylinder horizontal ('Cyl H'), 'Ball' or no tank ('---').

5.3.5.2.2 Max. Volume / Maximum Tank Volume

The maximum tank volume can be entered here. It corresponds to a completely filled tank.

Display (e.g.):

```
Tank parameters
◆MaxVol 10000 L
```

A value of between 0 and 99999 litres can be entered.

5.3.5.2.3 Height / Maximum Filling Height

Display (e.g.):

```
Tank parameters
◆Height 1600 mm
```

The maximum filling height of the tank in mm is entered as value between 0 and 9999.

5.3.5.2.4 Density Medium

Display (e.g.):

```
Tank parameters
◆Dens. 860 g/L
```

In order for the hydrostatic tank probe to work precisely, the density of the tank medium [g/l] must be entered. A value of between 0 and 9.999 can be entered.

5.3.5.2.5 Sensor Type

Display (e.g.):

```
Tank parameters
◆Sensor 200 mbar
```

Input of the sensor type (sensor range). There is a choice of the types 200, 300, 500 and 1000 mbar. The selection of the type of sensor is made according to the height of the tank. Hence, 200 mbar correspond to 200 cm water gauge or 230 cm diesel gauge, 300 mbar to 300 cm water gauge or 340 cm diesel gauge and so on.

5.3.5.2.6 Offset Sensor

Display (e.g.):

```
Tank parameters
◆ Offset 11 mm
```

Offset entry [mm] (corresponds to the effective installation height of the sensor relative to the floor of the tank). Using the '▶▶' button at the first position, with '-' it is possible to enter a negative offset (e.g. when the sensor is installed below the tank floor or inclined tank). A value of -999 to 9999 mm can be entered.

5.3.5.2.7 Min. Volume / Cut Off Volume

A limit value can be entered here, below further refuelling with the HDA eco will be disabled.

The value is checked before and during each refueling. The active refueling will be stopped to prevent dry running of the pump. The disablement is automatically cancelled after refilling the tank or switching the tank monitoring off.

Display (e.g.):

```
Tank parameters
◆ MinVol 5000 L
```

A value of 0 to MaxVol (see 5.3.5.2.2) can be entered.

5.3.5.2.8 Zero Point Compensation Sensor



Attention:

The sensor must be outside the liquid for the zero point compensation.

Display (e.g.):

```
Tank parameters
◆ Zero adjust?
```

The presently measured probe current is displayed after pressing the 'ENTER' button. The value should be within the range 4 mA +/- 0.2 mA.

Display (e.g.):

```
Zero compensation
Current: 4.05 mA
```

Pressing the 'ENTER' button twice executes the zero point compensation for the probe, while the 'EXIT' button aborts the compensation.

5.3.5.3 Tank Level (Level Probe Option)

The filling quantity in percent, the measured filling level and the filling quantity in litres are displayed.

Display (e.g.):

```
Tank      20%
510mm    6800L
```

6.1 Exchange of the buffer battery

The HDA eco automatic dispenser has a buffer battery for the backup of the time and the date in the event of a power failure. The battery must be exchanged every 5 years by an electrician.

When an exchange of the battery is necessary, use exclusively type CR2032 (3 V lithium). The battery should have a minimum shelf life of five years.

After exchanging the battery, check the system time and correct if necessary. (see section 5.3.4.3.1.1)

6.2 Type Plate and Warning Signs

- !** The warning signs attached to the device and the type plate must be well readable. Dirty signs must be cleaned, and replaced if necessary.

7 Trouble shooting What to do, if...?

...the LC display is too pale or dark

- The contrast setting is incorrect. It should be adjusted (chapter Fehler! Verweisquelle konnte nicht gefunden werden.) If the display is no longer legible, the contrast setting can be reset to the factory setting (44) by pressing the 'EXIT' button when switching the HDA eco on. The button must stay pressed until the date and time are displayed.

...the language has been accidentally changed.

- The language can be set 'blindly'. For this, change to the management mode (chapter Fehler! Verweisquelle konnte nicht gefunden werden.) and using the ,▼ button, change downwards three menu points following this, confirm with the 'ENTER' button, change downwards two menu points, then change downwards two menu points once again and confirm. The correct language can now be selected using the◀ and ,► buttons and then confirmed with 'ENTER'.

...after drawing the nozzle and/or starting the delivery of fuel, the pump is not switched on via the keyboard.

- The pump motor is not correctly connected to the switch output of the HDA eco. Check the connection. If an additional relay or safety device is used, check the connection of this component.
- The setting of the menu point 'nozzle switch y/n' (chapter Fehler! Verweisquelle konnte nicht gefunden werden.) is not correct. Adjust the setting.
- HDA eco is blocked. Unblocking should take place in the corresponding menu (chapter Fehler! Verweisquelle konnte nicht gefunden werden.).
- HDA eco is blocked due to too many zero fillings. It should be unblocked (chapter Fehler! Verweisquelle konnte nicht gefunden werden.) and the reason for the zero fillings should be dealt with, e.g. a defective pump, or a defective flow meter. As the case may be, the number of successive zero fillings should be increased (chapter Fehler! Verweisquelle konnte nicht gefunden werden.).

...the pump runs and the medium is pumped, but the quantity display does not change.

- The flow meter is not correctly connected to the pulse input of the HDA eco. The connection should be checked (chapter 2.5.1, chapter Fehler! Verweisquelle konnte nicht gefunden werden.).
- The flow meter is blocked. It should be checked and, as the case may be, cleaned.

...the pump runs and the medium is pumped, but the quantity display does not correspond with the quantity which is dispensed.

- The pulse value in the HDA eco does not correspond with that of the flow meter. It should be checked and adjusted (chapter 5.3.4.2.1) As the case may be, a calibration should be carried out (chapter 3.2).

...the fuse blows each time a delivery is started.

- The voltage consumption of the pump is too high for the HDA eco (max. 6.2 A). An additional relay or safety device should be used.
- The pump has a defect (e.g.: a blocked rotor). It should be checked.

...without intervention on the part of the user, the delivery is suddenly terminated.

- The value of the delivery limit is too low. It should be adjusted (chapter 5.3.4.1.6)
- The value of the maximum delivery time is too low. It should be adjusted (chapter 5.3.4.1.7)
- The delivery timeout value is too low. It should be adjusted (chapter 5.3.4.1.8)

...die serial RS232 connection does not work.

- The wrong COM port was selected on the computer. It is necessary to ensure that the COM port that is used and selected in the HD manager program correspond with each other.
- The interface connection is not correct. The connection should be checked (chapter 3.1.5.1, chapter 3.1.5.2).

...die serial RS422 connection does not work.

- The RS422 converter set does not have any supply voltage. The mains power pack (supplied) should be used.
- The wrong COM port was selected on the computer. It is necessary to ensure that the COM port that is used and selected in the HD manager program correspond with each other.
- The interface connection is not correct. The connection should be checked (chapter 3.1.5.3, chapter 3.).

- The setting of the DIP switch on the RS422 converter set is not correct. The connection should be checked (chapter 3.1.5.1, chapter 3.1.5.3).

8 Disposal

The device is to be emptied completely and the liquids properly disposed of in case it is taken out of service.

The equipment is to be disposed of properly when taken permanently out of service:



- Return old metal for recycling.
- Return plastic parts for recycling.
- Return electronic waste for recycling.



The water legal regulations are to be followed.

8.1 Return of batteries

Batteries must not be disposed of with the domestic waste. Batteries can be returned free of charge via a suitable collecting point or to the dispatch stores. Consumers are legally obliged to return used batteries.

Batteries that contain harmful substances are marked with a crossed out dustbin (see above) and the chemical symbol (Cd, Hg or Pb) of the heavy metal that is decisive for the classification as containing harmful substances:

1. "Cd" stands for cadmium.
2. "Pb" stands for lead.
3. "Hg" stands for mercury.

Annex A. Menu Structure Management Operation

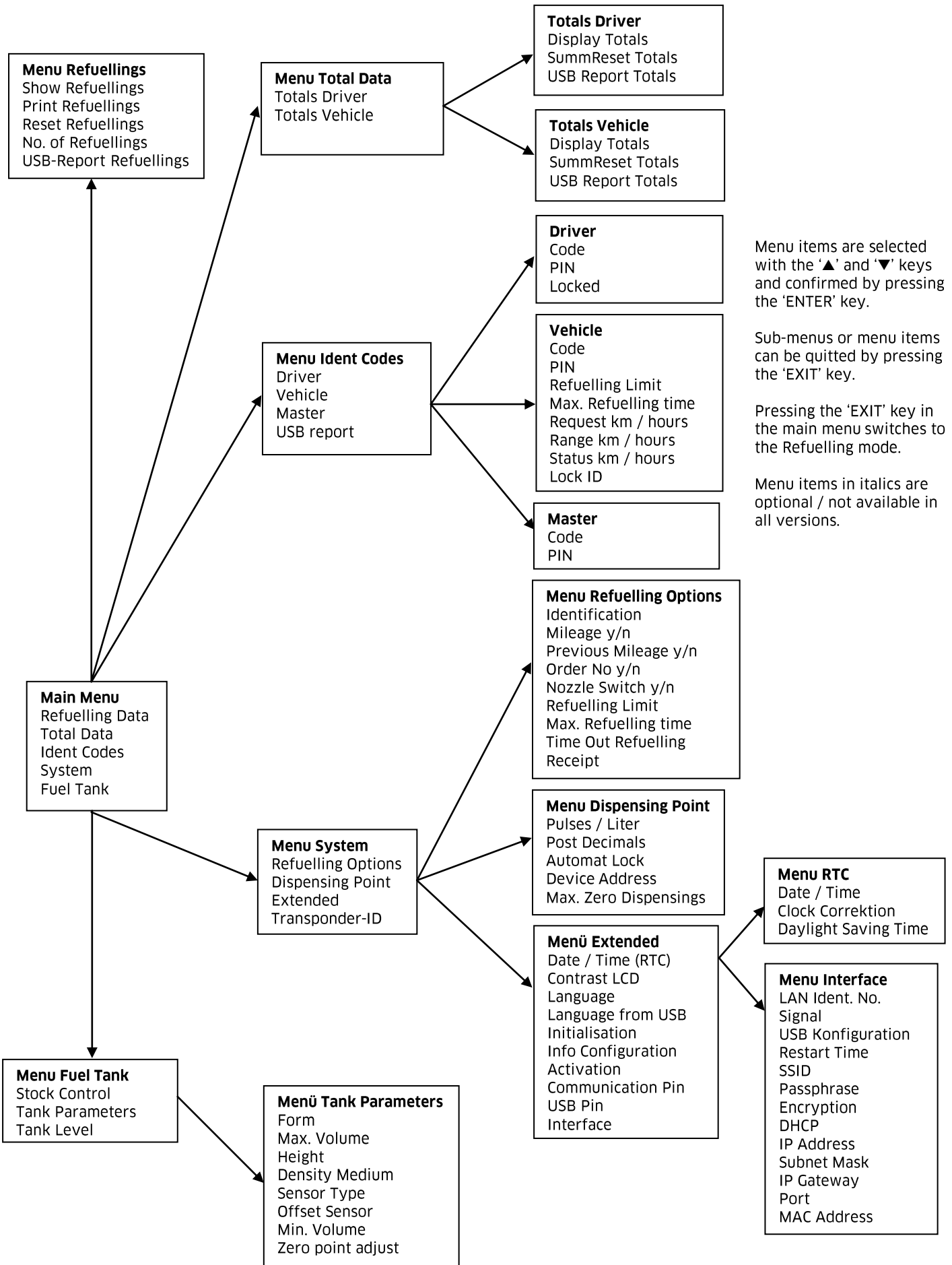

Annex B. Data export or Import via USB-flash-drive

Refuelling and ID data are written as a file to the USB flash drive or read from it (ID data only). The data is processed with the HD Manager eco program. It is preferable to use the USB flash drive included in the scope of supply or available as a special accessory; the suitability of third party makes cannot be guaranteed.

A maximum of approx. 240 files can be created on the USB flash drive. A corresponding error message is displayed if this number is exceeded. In this case older files are to be deleted.

Export of refuelling data

In the first export, all existing and not yet exported refuelling data are saved in the file 'DATA0001.TXT'. For all subsequent transmissions, all newer refuelling data are saved in the files 'DATA0002.TXT', 'DATA0003.TXT' and so on; i.e. a new file with an incrementing index is generated for each export procedure. If older files are deleted, moved or renamed, the procedure starts with 'DATA0001.TXT' again.

Export of ID data

ID data for drivers or vehicles are automatically saved in the file 'DATAOUT.TXT'. If the data are to be exported again at a later time (e.g. because new vehicles have been created), then this file must be deleted, moved or renamed. It will then be created again at the next data transfer.

Import or restoring of ID data

A previously saved ID data file 'DATAOUT.TXT' can be read into the HDM eco again by being renamed or copied to 'DATAIN.TXT'. This file can be also be created by the HD Manager eco program. After the transfer the restored file is renamed '_DATAIN.TXT', so that it is not read in again next time. Any already existing file with the name '_DATAIN.TXT' will be overwritten.

Refuelling data format

Each file comprises up to 2,000 consecutively numbered fuelling data records. Each refuelling data record is written in a line closed by CR, LF. The data fields are separated by a comma.

Data fields:

- Dispenser no.(numerical, two-digit),
- Dispensing point no.(numerical, two- digit),
- Dispensing No. (numerical, five-digit)
- Driver (numerical, four-digit),
- Vehicle (numerical, four-digit),
- Order (alphanumeric, eight-digit),
- Mileage (numerical, eight-digit),
- Quantity [L] (numerical, four integer digits, decimal point, post decimal positions.),
- Product-no. (numerical, two-digit),
- Date (DD.MM.YY),
- Time (HH.MM).
- Checksum (sum of all characters modulo 256 in ASCII representation)

Example:

```
01,01,00001,0001,0001,Test 1,00000100,0001.000,01,04.06.02,15:35,3B
01,01,00002,0002,0002,Test 2,00000200,0002.000,01,04.06.02,15:35,41
01,01,00003,0003,0003,Test 3,00000300,0003.000,01,04.06.02,15:35,47
01,01,00004,0004,0004,Test 4,00000400,0004.000,01,04.06.02,15:35,4D
01,01,00005,0005,0005,Test 5,00000500,0005.000,01,04.06.02,15:35,53
```

ID data format

Each file comprises up to 4000 ID data records, with a maximum of 2000 for drivers and 2000 for vehicles.

Each data record is written to CR, LF closed line when doing so. The data fields are separated by a comma.

Data fields:

- ID type (numerical, one-digit: ,1': Driver ID, ,2': Vehicle ID),
- ID number (numerical, four-digit),
- ID code (alpha numerical, max. ten-digit),
- ID pin (numerical, max. five-digit)
- ID blocked (numerical one-digit '0': no, '1': yes, ,)
- Entry mileage (miles) / operating hrs. (numerical, one-digit, '0': mileage (miles), '1': operating hours.)*
- Mileage window: (numerical, four-digit)*
- Max. dispensing time in minutes (numerical two-digit)*
- Dispensing limit in litres (numerical, four-digit)*
- Checksum (sum of all characters modulo 256 in ASCII representation)

*Values are only applicable to vehicles and ignored for drivers

Example:

```
2, 0001, 123, , 0, 0, 1000, 15, 0999, F7
2, 0123, 011A342F02, 55555, 0, 0, 1500, 15, 1100, EF
2, 0003, 3, , 0, 0, 0000, 00, 9999, D8
2, 0004, 4, , 0, 0, 0000, 00, 9999, DA
2, 0005, 0F0068FD24, , 1, 0, 0000, 00, 9999, BC
```

Generation of a language file

A new language file has to be examined and approved by HORN TECALEMIT. Please contact customer service at HORN TECALEMIT.

A faulty language file can impair the operation of the automatic dispenser.

The name of the language file is specified as 'LANGUAGE.CSV'.

Language file format

Each file consists of a number of lines. Each line contains two data fields separated from each other by comma or semicolon and corresponds to a unique text entry. Spaces between the data fields are not permitted and may possibly be considered to be part of the text. Each line must be closed by CR, LF.

Data fields:

Unique text ID (numeric, maximum three-digit) each text in the driver guidance is assigned exactly one ID

Text (1 - 16 characters) translation of the original text. Characters will be cut off if the maximum text length is exceeded.

Example:

0, Yes

1, No

2, Tank level

...

HORN GmbH & Co. KG
Munketoft 42
24937 Flensburg
Deutschland

T +49 461-8696-0
F +49 461-8696-66

www.tecalemit.de
info@tecalemit.de